

T2™

Recon Nailing System

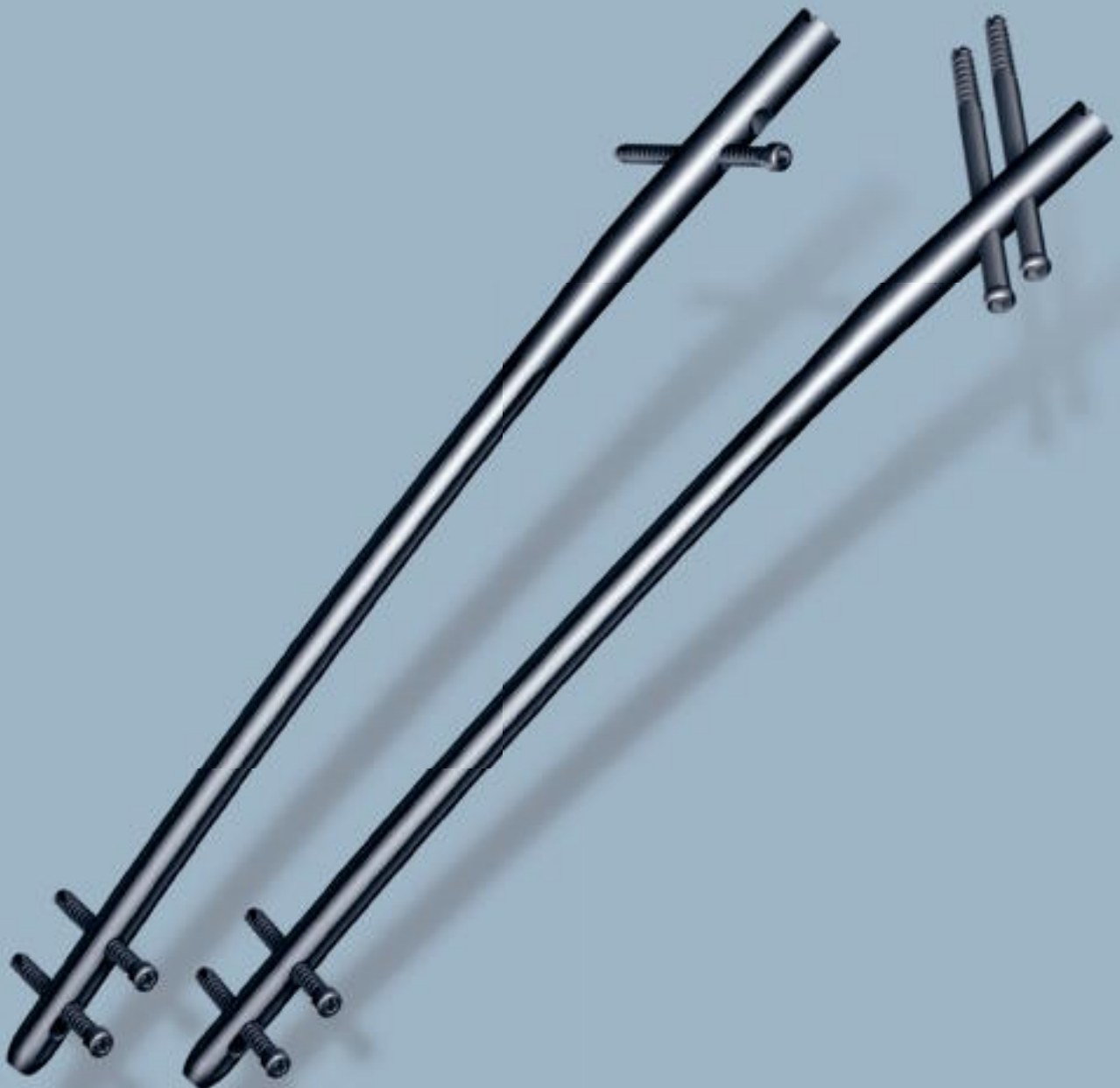

Introduction

Contributing Surgeons:

Kyle F. Dickson, M.D.

Director of Surgery & Chief of Orthopaedics
Charity Hospital
Associate Professor & Director of Orthopaedic Trauma
Tulane University
Assistant Clinical Professor
Louisiana State University
New Orleans, Louisiana
USA

We greatly acknowledge and appreciate the contributions to this operative technique made by:

Anthony T. Sorkin, M.D.

Rockford Orthopaedic Associates, LLP
Clinical Instructor
Dep. of Surgery University of Illinois
College of Medicine
Director Orthopaedic Traumatology
Rockford Memorial Hospital
Rockford, Illinois
USA

Ariaan D.P. van Walsum, MD

Trauma surgeon
Medical Spectrum Twente
Enschede
Netherlands

Don Weber MD, FRCSC

Associate Clinical Professor of
Orthopaedics
Chief of Orthopaedics
University of Alberta Hospital
Edmonton, Alberta
Canada

This publication sets forth detailed recommended procedures for using Stryker Trauma devices and instruments.

It offers guidance that you should heed, but, as with any such technical guide, each surgeon must consider the particular needs of each patient and make appropriate adjustments when and as required.

A workshop training is required prior to first surgery.

Contents

1.	Introduction	4
1.1.	Implant Features	4
1.2.	Instrument Features	6
2.	Indications	7
3.	Pre-operative Planning	7
4.	Locking Options	8
5.	Operative Technique	9
5.1.	Patient Positioning and Fracture Reduction	9
5.2.	Incision	9
5.3.	Entry Point	10
5.4.	Reaming	12
5.5.	Nail Selection	13
5.6.	Nail Insertion	13
5.7.	Guided Locking for Recon Mode (via Target Device)	14
	(A) Nail and Lag Screws Positioning	14
	(B) Lag Screw Selection and Insertion	18
5.7.1.	Guided Locking for Antegrade Femoral Mode (via Target Device)	20
5.8.	Freehand Distal Locking	23
5.9.	Blocking Screw or End Cap Insertion	24
5.10.	Nail Removal	24
<hr/>		
	Ordering Information – Implants	25
	Ordering Information – Instruments	26

Introduction

1. Introduction

Over the past decades **antegrade femoral nailing** has become the treatment of choice for most femoral fractures.

As an addition to the **T2™ Nailing System**, Stryker Trauma has created a new generation femoral implant: the **T2™ Recon Nail** for the treatment of complex, as well as more common fractures.

The advantages of using intramedullary fixation for the treatment of proximal femur fractures include less soft tissue dissection and stable fracture fixation with a load sharing device.

Through the development of a common, streamlined instrument system and intuitive surgical approach, both in principle and in detail, the **T2™ Recon Nail** offers **the opportunity for significantly increased speed and functionality** for the treatment of fractures and simplifies the training requirements for all personnel involved.

Furthermore, the **T2™ Recon Nail** offers the following competitive advantages:

- **Versatility to switch from a standard antegrade femoral nailing to a recon option without changing the nail**
- **An optional Set Screw, Recon that can be tighten down onto the superior Lag Screw, thus minimizing the potential sliding of the proximal Lag Screw.**
- **Static or dynamic distal locking options for the antegrade femoral mode**
- **Trochanteric entry point**
- **Reduced proximal nail diameter allowing freehand placement of accessory K-Wires around the nail (anterior and posterior) for precise femoral neck fracture reduction**

1.1. Implant Features

The **T2™ Recon Nail** is the realization of superior biomechanical intramedullary stabilization using strong, cannulated implants for the internal fixation of the Femur.

As with all other T2 Nails, the **T2™ Recon Nail** is made of **Type II anodized Titanium Alloy (Ti6Al4V)** for enhanced biomechanical and biomedical performance.

The **T2™ Recon Nail** features a **125° CCD angle and a 10° anteversion angle for the 2 proximal holes which utilize 6.5mm cannulated Lag Screws.** With this lower **CCD angle**, easy insertion of 2 screws into the femoral head can be achieved.

Alternatively a **proximal 70° Oblique hole with 7° retroversion** for a 5mm Fully Threaded Screw can target the Lesser Trochanter in the Femoral Antegrade mode.

The 6.5 mm cannulated Lag Screws have a unique thread design providing a better grip, improved front cutting flutes for a lower insertion torque and thinner flanks for less bone removal. Secure placement of the Lag Screws within even very small neck diameters can be achieved due to the optimal design of a 10.5mm inner, therefore 17mm outer distance between the two 6.5mm Lag Screws.

Two Set Screws are available:

- a **Set Screw, Recon** to tighten down on the proximal Lag Screw (for the Recon Mode) and
- a **Set Screw, Antegrade** to tighten down on the oblique Fully Threaded Screw (for the Femoral Antegrade Mode).

Available as **left and right versions**, the **T2™ Recon Nail** incorporates an antecurvature radius of **2000mm**, as well as a **4° lateral valgus bend** for trochanteric insertion.

The **distal locking configuration** features a round and an oblong hole to allow for **static or dynamic distal locking.**

Low profile 5mm cortical screws, common to the T2 Nailing System, are designed to simplify the surgical procedure and promote a minimally invasive approach.

- Fully Threaded Locking Screws are available for distal locking (Recon or Femoral Antegrade Mode) and for the proximal locking in Femoral Antegrade Mode.

End Caps are available in various length to provide a **“best fit”** for every indication.

See the **detailed chart on the next page** for the design specifications and size offerings of the implants.

Features

T2™ Recon Nail

Diameter 9, 11, 13 and 15mm
(Left and Right)

Sizes 340–480mm
(in 20mm increments)

Note:
Proximal diameter is 13mm for the 9 and 11mm Nails and 15mm for the 13 and 15mm Nails.

Note:
Screw length is measured from top of head to tip.

5.0mm Fully Threaded Locking Screws

L = 25–120mm

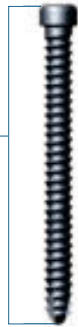

6.5mm cannulated Lag Screws

L = 65–130mm



End Caps



Set Screw, Recon

Set Screw, Antegrade

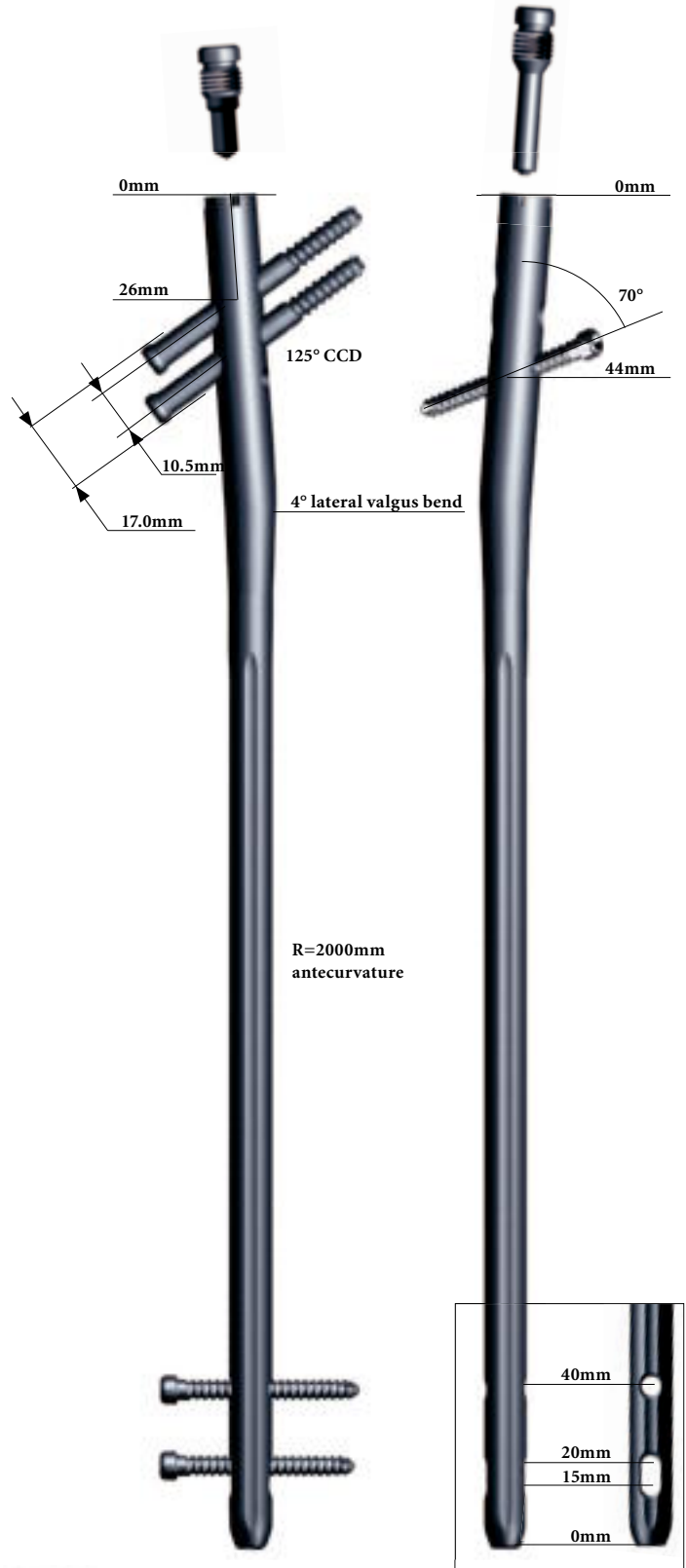

Features

1.2. Instrument Features

The major advantage of the instrument system is a breakthrough in the integration of a **core instrument platform** which can be used not only for the complete **T2™ Nailing System**, but represents the platform for all future Stryker Trauma nailing systems, reducing complexity and inventory. **The T2™ instrument platform** offers advanced precision and usability, and features ergonomically styled targeting devices.

Except for the addition of a small number of dedicated instruments, the T2™ Femur instrument platform is used for the **T2™ Recon Nail**.

Dedicated instruments for the **T2™ Recon Nail** include the **Recon Targeting Device** which has one **Nail Adapter** and two Targeting Arms:

- a **Targeting Arm, Recon** (1806-3002) used for the placement of two 6.5mm cannulated Lag Screws into the femoral head in the Recon mode,
- a **Targeting Arm, Antegrade** (1806-3003) used for insertion of the oblique screw in the Antegrade mode.

In addition to the advanced precision and usability, the instruments are number and color coded to indicate their usage during the surgical procedure. The number coding indicates the step during the procedure in which the instrument is used.

With the exception of the carbon fiber targeting device, all dedicated instruments for the recon mode have a “bronze” color code.

This makes it easy to differentiate them from the core platform instruments.



Nail Adapter



Targeting Arm, Recon



Targeting Arm, Antegrade

Drills

Drills feature color coded rings:

4.2mm = Green

(Consistent with the T2™ Instrument Platform, this drill features a green color ring.)

The 4.2mm drills are used for 5.0mm Fully Threaded Locking Screws (either for distal locking or for proximal oblique locking).

6.5mm

Stepdrill for Lag Screw has the “bronze” color coding.

Indications

2. Indications

The T2™ Recon Nail is indicated for:

- Open and closed femoral fractures
- Pseudarthrosis and correction osteotomy
- Pathologic fractures and impending pathologic fractures
- Intertrochanteric and Subtrochanteric fractures
- Ipsilateral neck/shaft fractures

3. Pre-operative Planning

An X-Ray Template, Recon (1806-3080) is available for pre-operative planning. Thorough evaluation of pre-operative radiographs of the affected extremity is critical. Careful radiographic examination of the trochanteric region and neck regions can reduce the potential of intra-operative complications.

According to the fracture type, either Recon or Antegrade Femoral Mode can be chosen.

Evaluation of the femoral neck angle on the pre-operative X-Rays is mandatory as the T2™ Recon Nail has a fixed 125° neck angle for the two Lag Screws and proper placement of both Lag Screws in the femoral head is essential.

If possible, X-Rays of the contralateral side should be used to determine the normal neck angle and length of the femur.

The proper nail length should extend from the Tip of the Greater Trochanter to the Epiphyseal Scar.

Note:

Check with local representative regarding availability of nail sizes.

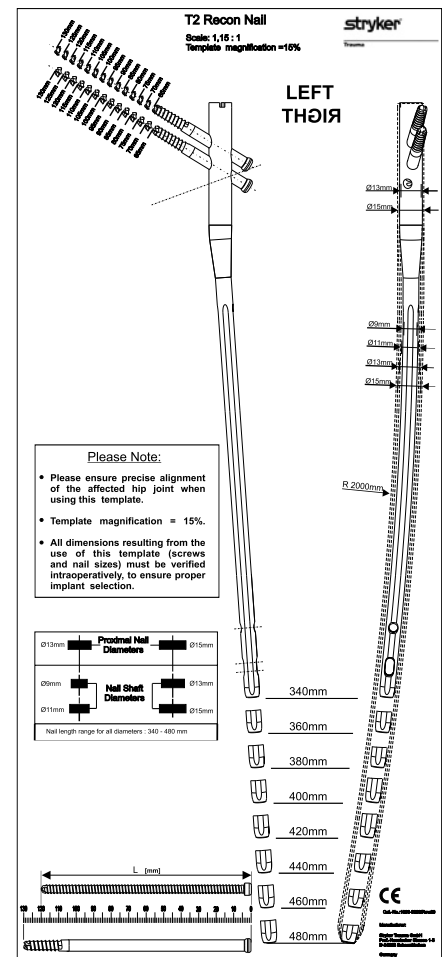

Operative Technique

4. Locking Options

The T2™ Recon Nail can be locked proximally either with two Lag Screws (Recon Mode, Fig. 1) or with one Fully Threaded Screw (Antegrade Femur Mode, Fig. 2).

For both Recon and Antegrade Femur applications, depending on fracture pattern, either static or dynamic distal locking can be used.

Recon Mode



Fig. 1

Antegrade Femoral Mode



Fig. 2

Operative Technique

5. Operative Technique

5.1. Patient Positioning

Patient positioning for T2™ Recon Nail insertion is surgeon dependent. However, it is recommended to position the patient in supine or lateral position on a fracture table, to allow closed reduction of the fracture (Fig. 3).

Manipulate and reduce the fracture in the usual fashion, according to the fracture type. Reduction should be achieved as anatomically as possible. If this is not possible, reduction in one plane should be complete, leaving reduction in the other plan to be achieved prior to reaming and nail insertion.

The unaffected leg is abducted as far as possible to ease image intensifier positioning. This will also allow easier entry point access.

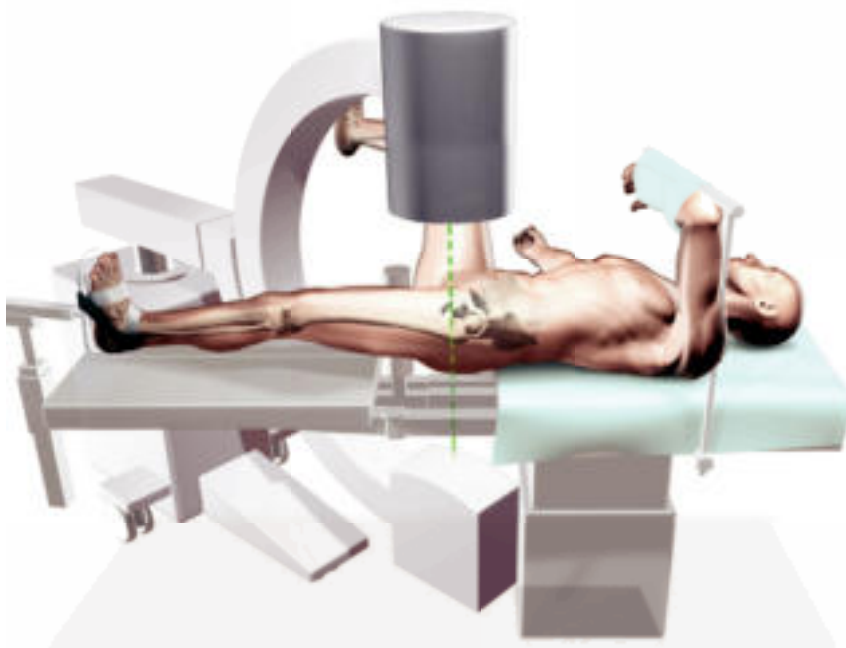

Fig. 3

5.2. Incision

The design of the T2™ Recon Nail, with a 4° lateral valgus bend, will **only** allow for insertion through the **Tip of the Greater Trochanter**.

With experience, the Tip of the Greater Trochanter can be identified by palpation (Fig. 4).

A longitudinal skin incision of approximately 3–5cm is made starting just above the Greater Trochanter to the Iliac Crest (Fig. 5). The incision is then deepened to expose the Tip of Greater Trochanter.

Smaller or larger incisions may be used based on individual patients anatomy and at the surgeons discretion.

Note:

The targeting instruments of the T2™ Recon Nail have been designed to allow for a more percutaneous approach.



Fig. 4



Fig. 5

Operative Technique

5.3. Entry Point

• The Tip of the Greater Trochanter

The entry point is located at the junction of the anterior third and posterior two-thirds of the Greater Trochanter, on the medial edge of the tip itself (Fig. 6).

Note:

Before opening the Tip of Greater Trochanter, use image intensifier views (A/P and M/L) to confirm correct identification of the entry point.

The medullary canal can be opened with the

- **Curved Awl** (1806-0040)/Curved Awl, 90° Handle (1806-0041) or
- **One Step Conical Reamer** (1806-3010 or 1806-3015).

Note:

During opening of the entry portal with the Awl, dense cortex may block the tip of the Awl. An optional Awl Plug (1806-0032) can first be inserted through the Awl to avoid penetration of bone debris into the cannulation of the Awl shaft, and then removed for Guide Wire insertion.

• Entry point with Curved Awl

Once the Tip of the Greater Trochanter has been penetrated, the Ø3 × 1000mm Ball Tip Guide Wire (1806-0085S)* may be advanced through the cannulation of the **Curved Awl** with the Guide Wire Handle and Chuck (1806-0095 and 1806-0096) (Fig. 7).

- The proximal femur may then be prepared with the One Step Conical Reamer over the Guide-Wire.

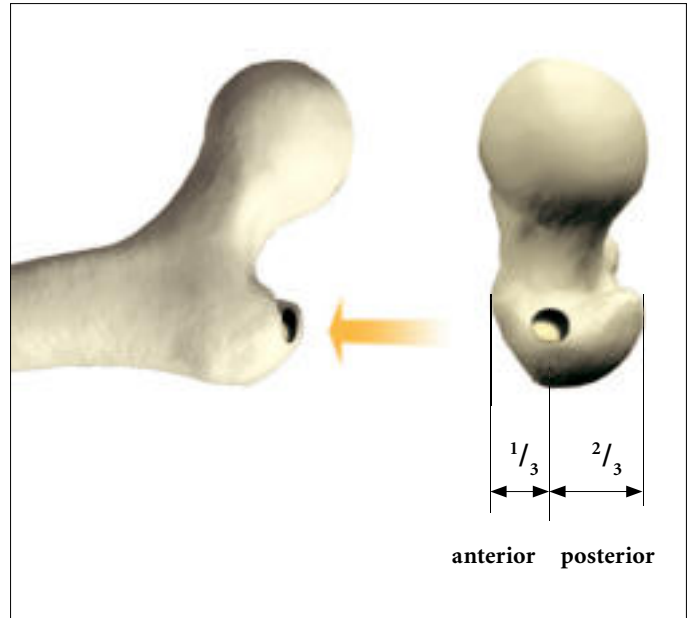

Fig. 6



Fig. 7

*Outside the U.S. products can be ordered also non sterile by eliminating the "S" at the end of the Ref. No.

Operative Technique

• Entry point with One Step Conical Reamer

Alternatively, the 13mm diameter One-Step Conical Reamer (1806-3010) for the 9 and 11mm nails or the 15mm diameter Reamer (1806-3015) for the 13 and 15mm nails may be used for opening the medullary canal and reaming of the trochanteric region.

Under image intensification control, the entry point is made with a $\text{Ø}3.2 \times 400\text{mm}$ K-Wire, Recon (1806-3030S)* attached to the Guide Wire Handle and advanced into the medullary canal. Confirm its placement within the center of the medullary canal on A/P and lateral image intensifier views.

Note:

The K-Wire, Recon used for the entry point should not be used again for the Lag Screw insertion. It is recommended to utilize a new K-Wire.

The Protection Sleeve, Recon (1806-3057) and Multi-hole Trocar (1806-3055) are positioned with the central hole over the K-Wire.

Note:

The Multi-hole Trocar has a special design for more precise insertion of the $\text{Ø}3.2\text{mm}$ Recon K-Wire (Fig. 8). Beside the central hole, 4 other holes are located eccentrically at different distances from the center (Fig. 8a) to easily revise insertion of the guiding K-Wire in the proper position (Entry Point).

When correct placement of the guiding K-Wire is confirmed on image intensifier views (A/P and lateral), keep the Tissue Protection Sleeve in place and remove the Multi-hole Trocar.

The T-Handle (702628) is attached to the One-Step Conical Reamer and **hand reaming** is performed over the K-Wire through the Tissue Protection Sleeve (Fig. 9).

The K-Wire is then removed and replaced with the $\text{Ø}3 \times 1000\text{mm}$ Ball Tip Guide Wire.

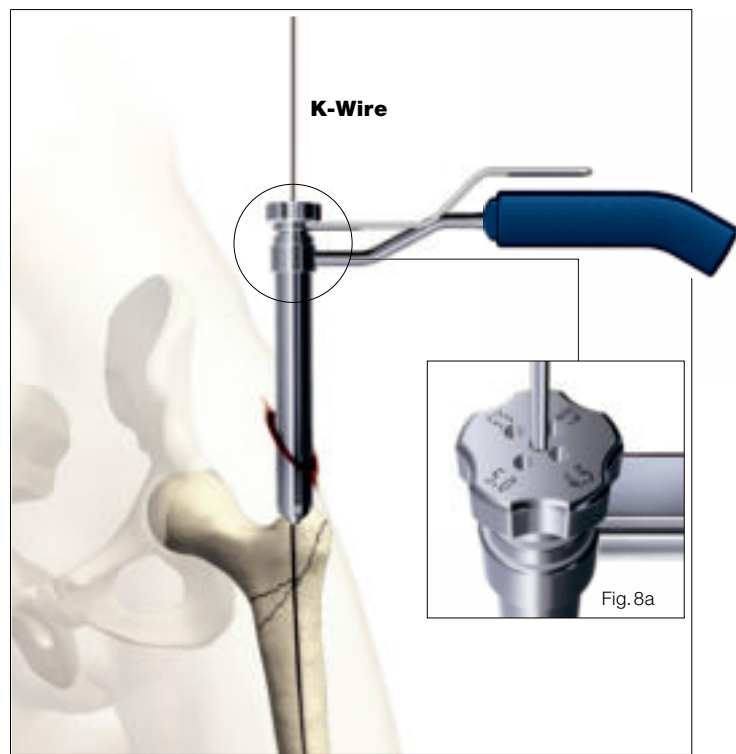

Fig. 8



Fig. 9

*Outside the U.S. products can be ordered also non sterile by eliminating the "S" at the end of the Ref. No.

Operative Technique

5.4. Reaming

The Ø 3×1000mm Ball Tip Guide Wire is inserted with the Guide Wire Handle through the fracture site to the level of the Epiphyseal Scar.

The Ø 9mm Universal Rod (1806-0110) with Reduction Spoon (1806-0125) may be used as a fracture reduction tool to facilitate Guide Wire insertion through the fracture site (Fig. 10).

Note:
The Ball Tip at the end of the Guide Wire will stop the Bixcut™ reamer* head (Fig. 11).

Note:
Prior to reaming, it is important to check the centered intramedullary position of the Guide Wire with the image intensifier. Lateral displacement of the Guide Wire could lead to resection of more bone on the lateral side of the wire, which in turn will lead to an offset position of the nail and the risk of fracturing the shaft.

Note:
Make sure that the reduction is maintained throughout the reaming process.

Reaming is commenced in 0.5mm increments until cortical contact occurs (Fig. 12).

For easier nail insertion, the medullary canal should be reamed 2mm more than the diameter of selected nail.

Note:
The T2™ Recon Nail may be inserted without reaming of the subtrochanteric and dyaphyseal region of the femur, particularly in elderly patients with wide medullary canals. If appropriate, after the trochanteric region is prepared with the One-Step Conical Reamer, the nail can be inserted without further reaming of the medullary canal.

Reaming of the trochanteric region is needed (Fig. 13) as the proximal nail diameter (driving end) is larger than the nail diameter (13mm for the 9 and 11mm diameter nails and 15mm for the 13 and 15mm diameter nails).

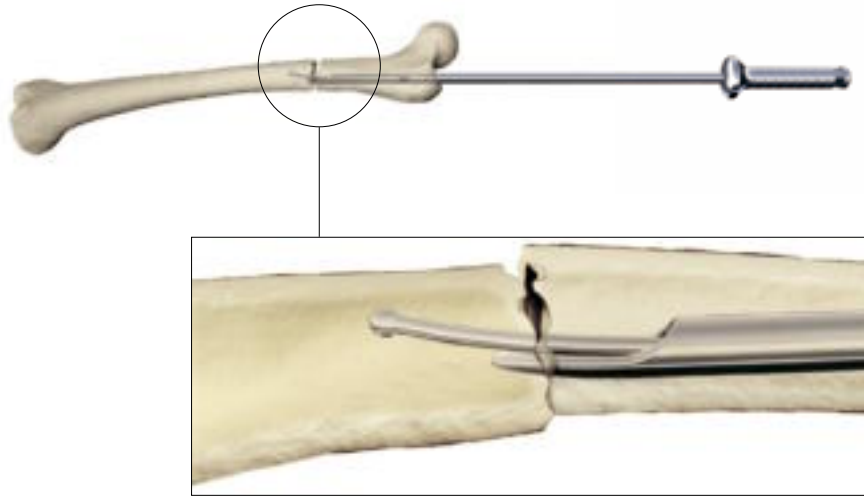

Fig. 10



Fig. 11



Fig. 12

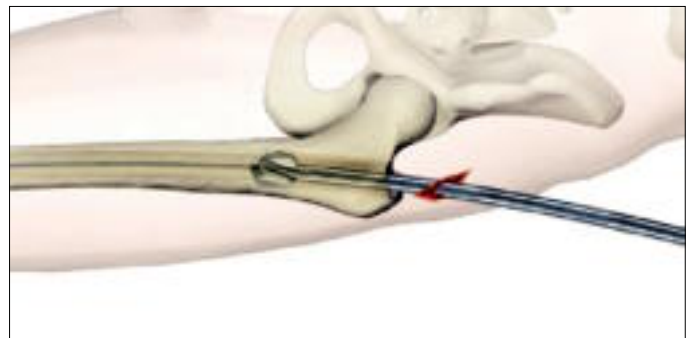

Fig. 13

For both reamed or unreamed applications, the proximal 5cm of the trochanteric region must be opened to at least 13mm or 15mm, (depending on the proximal diameter of the nail).

* see pages 28–29 for additional Bixcut™ Reamer system details

Operative Technique

5.5. Nail Selection

Diameter

The diameter of the selected nail should be 1.5–2.0mm smaller than that of the last reamer used.

Length

Nail length may be determined by measuring the remaining length of the Guide Wire. The Guide Wire Ruler (1806-0020) may be used by placing it on the Guide Wire and reading the correct nail length at the end of the Guide Wire on the Guide Wire Ruler (Fig. 14 and 15).

Strike Plate, Recon (1806-3096) can be attached to the Nail Adapter and the Slotted Hammer (1806-0170) may be used to further insert the nail (Fig. 17).

Note:

The nail must progress smoothly, without excessive force. If too much resistance is encountered, removal of the nail and additional reaming may be necessary.

Note:

Remove the Guide Wire prior to drilling or K-Wire insertion.



End of Guide Wire Ruler equals Measurement Reference

Fig. 14

5.6. Nail Insertion

Upon completion of reaming, the appropriate size nail is ready for insertion. A unique design feature of the T2 Recon Nail is that the $\text{Ø}3 \times 1000\text{mm}$ Ball Tip Guide Wire does not need to be exchanged.

The selected nail is assembled onto the Nail Adapter (1806-3001) with the Nail Holding Screw (1806-3005) (Fig. 16a). Securely tighten the Nail Holding Screw with the Screwdriver Shaft, Ball Tip (1806-3090) and T-Handle (702628) so that it does not loosen during nail insertion.

Note:

Check the correct assembly by passing the Stepdrill for Lag Screw through the Tissue Protection Sleeve, Recon and/or Drill Sleeve, Recon placed in the corresponding hole of the Targeting Arm, Recon, into the holes of the nail (Fig. 16b).

For the Femoral Antegrade Mode, use the Targeting Arm, Antegrade with the Tissue Protection Sleeve and Drill Sleeve assembly to pass the $\text{Ø}4.2 \times 340\text{mm}$ Drill through the oblique hole of the nail.

The nail is advanced through the entry point past the fracture site to the appropriate level.

If dense bone is encountered, first re-evaluate that sufficient reaming has been achieved, then, if necessary, the



Fig. 15



Fig. 16a



Fig. 16b



Fig. 17

Operative Technique

5.7. Guided Locking for Recon Mode (via Target Device)

(A) Nail/Lag Screws Positioning

Drive the T2 Recon Nail to the depth that correctly aligns the proximal screw holes coaxial with the femoral head and neck under fluoroscopic control.

Two aspects regarding the Nail/Lag Screws position must be carefully checked with the image intensifier before drilling into the femoral head:

- Alignment of the anteversion (lateral view)
- Depth of Nail insertion (A/P view) (Fig. 18).

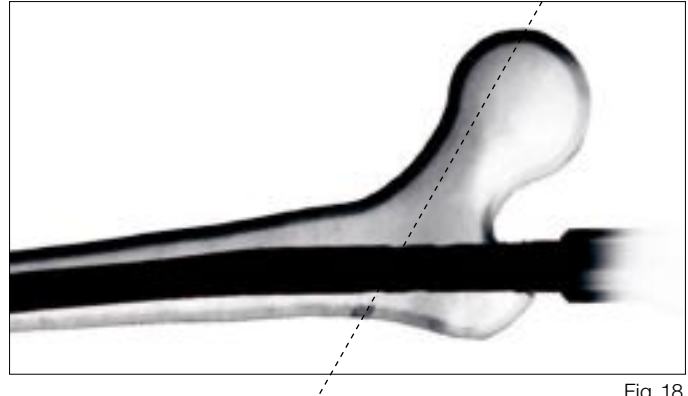

Fig. 18

The distal Lag Screw should run along the calcar region (on the A/P view) and centered into the femoral neck and head (on Lateral view).

Note:

Correct placement of the Nail/Lag Screws can be achieved with or without the optional One Shot™ Device (1213-3010).

• Nail/Lag Screws Positioning without the One Shot™ Device

Attach the Targeting Arm, Recon (1806-3002) to the Nail Adapter (1806-3001) by securely tightening the Fixation Screw (1806-1007) (Fig. 19).



Fig. 19

Note:

Please make sure that no pressure is applied on the Targeting Arm, Recon while tightening the Fixation Screw, in order to avoid possible malalignment.

Slide the first Tissue Protection Sleeve, Recon (1806-3045) together with the K-Wire Sleeve, Recon (1806-3040) into the distal (A) hole on the Targeting Arm, Recon by pressing the distal safety clip (Fig. 20). The mechanism will keep the sleeve in place and prevent it from sliding out. A small skin incision is made and the assembly is pushed through until it is in contact with the lateral cortex.



Fig. 20

Operative Technique

Place a K-Wire, Recon (1806-3030S)* into the K-Wire Inserter (1806-3070) and attach it to the T-Handle (702628). The K-Wire is then manually advanced through the K-Wire Sleeve until it reaches the subchondral bone of the femoral head (Fig. 21). Alternatively, the K-Wire Inserter can be attached to a Power Tool and the K-Wire, Recon inserted to the same depth.



Fig. 21

Note:

With the image intensifier, verify if the tip of the K-Wire is placed along the calcar region in the A/P view (depth of nail insertion), and central on the lateral view (correct anteversion) (Fig. 22).

If the K-Wire is wrongly positioned, the first step is to remove it and then to reposition the nail.

More commonly, the nail is positioned too high and repositioning should be carried out either by hand or by using the Strike Plate, Recon (1806-3096) placed into the Nail Adapter, inserting the nail further. If a higher position is required, the Universal Rod (1806-0110) and Slotted Hammer (1806-0170) may then be attached to the Strike Plate, Recon to carefully and smoothly extract the assembly (Fig. 23).

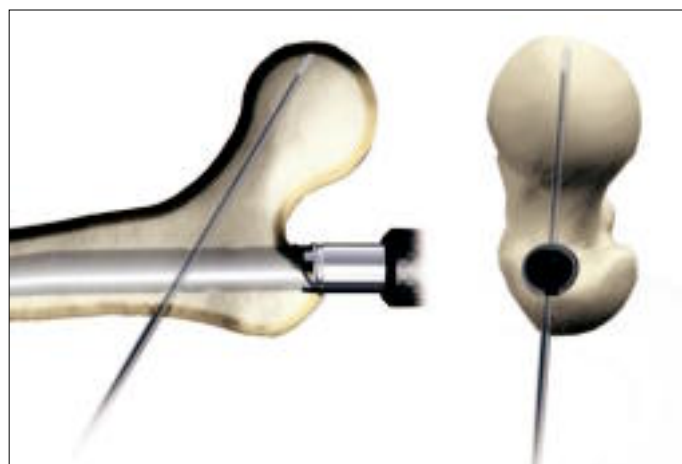

Fig. 22

The new position is checked again with the image intensifier as described above.

Note:

In case of very dense femoral neck bone, the K-Wire Recon might deflect during insertion. If any deflection of the first K-wire is noticed, it is recommended to use the solid Step drill technique.

*Outside the U.S. products can be ordered also non sterile by eliminating the "S" at the end of the Ref. No.



Fig. 23

Operative Technique

• Nail/Lag Screws Positioning with the One Shot™ Device

Alternatively, the **One Shot™ Device** (1213-3010) can be used to determine the correct K-Wire, lag screws and nail placement (Fig. 24). The One Shot™ Device is made of carbon fiber and works by providing a target to indicate the position of the K-wire on the fluoroscope screen. The target contains 3 radio-opaque wires embedded in the arm – a dashed inner wire and two solid outer wires. These wires work like a gun sight to indicate the position of the K-wire.

The One Shot™ Device is attached by slightly pressing the grip and releasing it when positioned onto the Tissue Protection Sleeve. To reposition or remove the device, the grip must be depressed.

Note:

The use of the One Shot™ Device should not interfere with or replace any steps in the **T2™ Recon Nail Operative Technique**.

While depressing the attachment grip, the device is positioned between the anterior aspect of the patient's hip and the fluoroscope screen positioned for an A/P view of the hip (Fig. 24 and 25).

Note:

It is important to drape the patient such that the One Shot™ Device does not interfere with any drapes anterior to the patient's hip.

When positioned correctly, the target will appear in the fluoroscopic image (A/P view), with the dashed inner wire in the middle of the two solid outer wires (Fig. 25). If it does not, the One Shot™ Device should be moved towards or away from the patient by depressing the grip slightly until the target is seen as described above.



Fig. 24

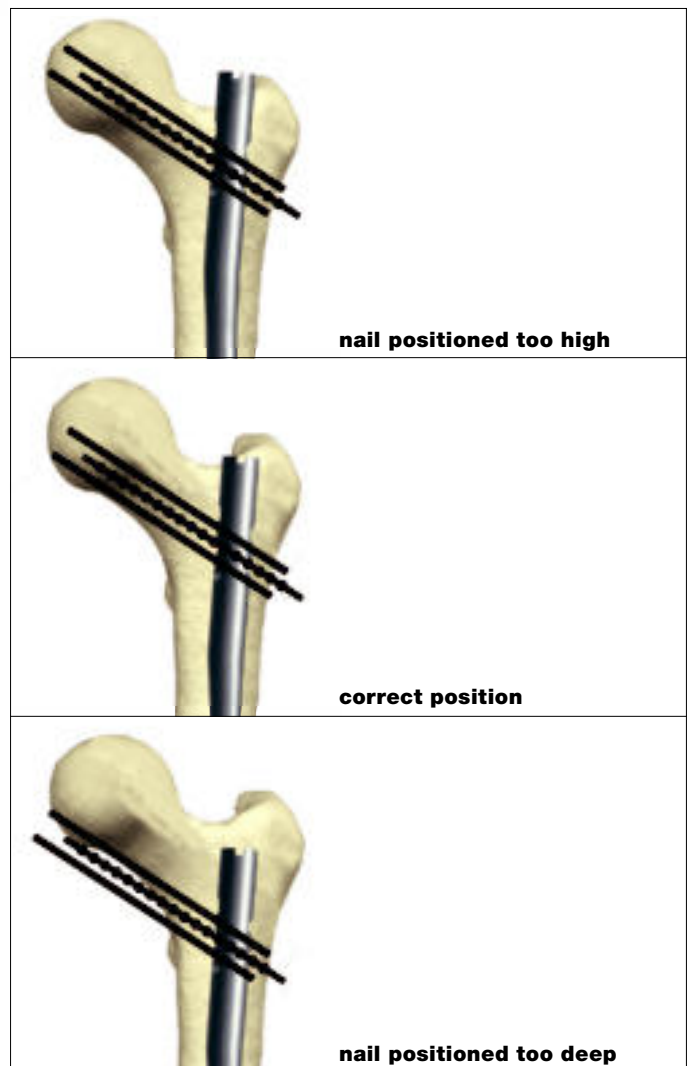

A/P view

Fig. 25

Operative Technique

Note:

The **One Shot™ Device** cannot be rotated 90° with the Tissue Protection Sleeve because it will be stopped by the Nail Adapter.

Therefore, the C-Arm must be turned more than 90°, in order to get a lateral view of the **One Shot™ Device**.

To identify the position of the K-wire accurately, the dashed wire of the target must appear between the two solid wires at the desired position. If the position is incorrect the T2 Recon Nail may be repositioned by either pulling backwards or pushing forwards. The K-wire can then either be placed into the femur or, the targeting arm is held in place until the K-wire's position in the Lateral view has been determined (Fig. 26). When positioned correctly, the target will appear in the fluoroscopic lateral views (Fig. 27).

If the dashed wire of the target appears between the two solid wires, insert the K-Wire (Fig. 28) and continue following the **T2™ Recon Nail Operative Technique**.

Note:

Prior to advancing the K-Wire, check the correct guidance through the K-Wire Sleeve. Do not use bent K-Wires.

Note:

The K-Wire inserted into the most distal Lag Screw hole of the nail helps in achieving the correct positioning of the nail (depth & rotation) with minimal resection of bone in case repositioning is needed.

After this is achieved, the surgeon can choose to use either

- the cannulated step drill to perform insertion of the Lag screws over the K-Wire or,
- the solid step drill to perform insertion of the Lag screws without the K-Wire guidance.

Note:

If any deflection of the first K-wire is noticed, it is recommended to use the solid Step drill technique.

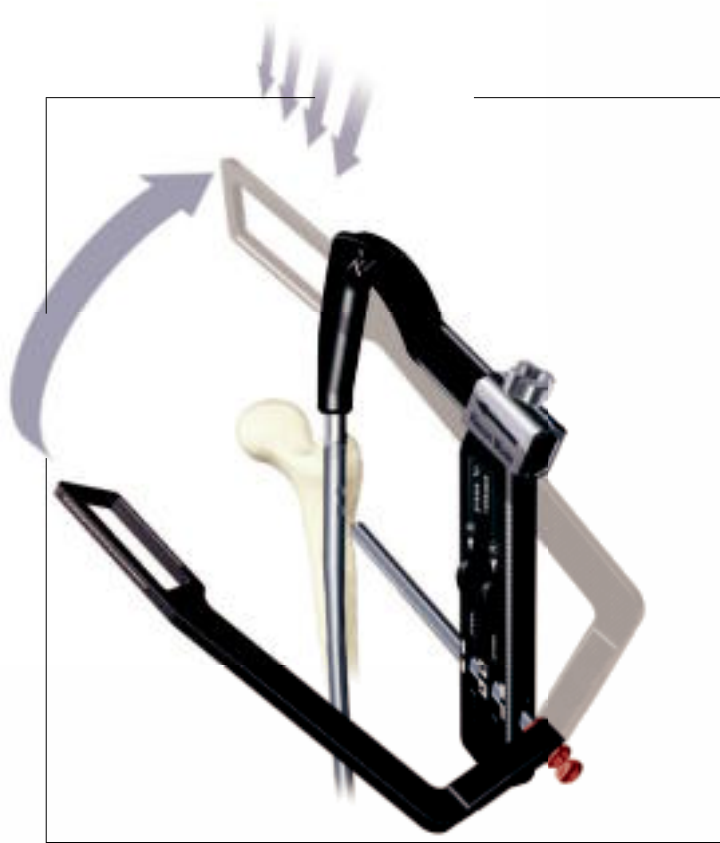

Fig. 26

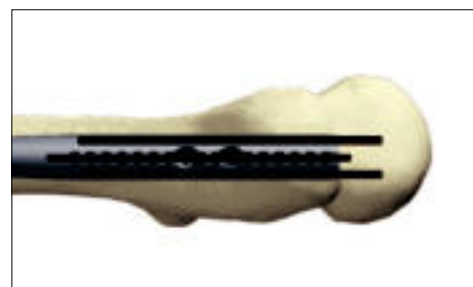

Fig. 27



Fig. 28

Operative Technique

(B) Lag Screw Selection and Insertion

Option 1:

Cannulated Step-drill Technique

After achieving a satisfactory position of the first K-Wire, Recon, slide the second Tissue Protection Sleeve, Recon together with the K-Wire Sleeve, Recon into the proximal hole on the Targeting Arm, Recon by pressing the proximal (B) safety clip. A small skin incision is made and the assembly is pushed through until it is in contact with the lateral cortex (Fig. 29).

Place a second Recon K-Wire into the K-Wire Inserter and attach it to the T-Handle or power tool. The K-Wire is then advanced through the K-Wire Sleeve until it penetrates the subchondral bone of the femoral head.



Fig. 29

Note:

Correct placement of the K-Wire tip in subchondral bone must be checked with image intensifier in both A/P and Lateral views.

The required length of the Lag Screw is measured using the Lag Screw Gauge, Recon (1806-3035). Before starting to measure, ensure that the Tissue Protection Sleeve and K-Wire Sleeve assembly is firmly pressed against the lateral cortex of the femur (Fig. 30).

Take the Lag Screw Gauge, Recon and place it directly under the distal K-Wire and against the K-Wire Sleeve (Fig. 30). The correct Lag Screw length corresponds to the measurement indicated at the end of the K-Wire on the Lag Screw Gauge.

This length will then be set on the cannulated Stepdrill for Lag Screw, Recon (1806-3025) (Fig. 31).



Fig. 30



Fig. 31

Operative Technique

Note:

Before proceeding with drilling for the selected Lag Screw, check the A/P fluoroscopic views to see if the two K-Wires, Recon are parallel.

The distal K-Wire Sleeve is removed while the Tissue Protection Sleeve remains in position (Fig. 32a). The cannulated Ø6.5mm Stepdrill for Lag Screw, Recon (1806-3025) is forwarded through the Tissue Protection Sleeve and pushed onto the lateral cortex. The stop on the drill will only allow drilling up to 5mm before the K-Wire ends (Fig. 32b).

Note:

Do not use the cannulated Stepdrill for Lag Screw, Recon over a deflected K-Wire.

Using the Screwdriver, Recon (1806-3060), the correct Lag Screw is inserted through the Tissue Protection Sleeve and threaded up to the subchondral bone of the femoral head. The screw is near its' proper seating position when the groove around the shaft of the screwdriver is approaching the end of the Tissue Protection Sleeve (Fig. 33).

Alternatively, the Screwdriver Shaft, Recon (1806-3050) assembled into the T-Handle (702628) can be used for the Lag Screw insertion.

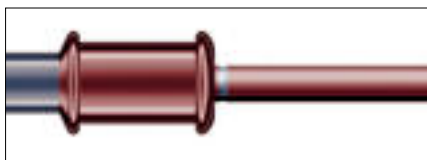

The required length of the second Lag Screw is measured using the Lag Screw Gauge, Recon. Repeat the same surgical steps for drilling and insertion of the proximal Lag Screw (Fig. 34).



Fig. 32a

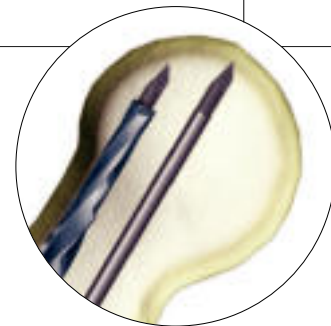

Fig. 32b



Fig. 33



Fig. 34

Operative Technique

Option 2:

Solid Step-drill Technique

If any deviation of the distal K-Wire is noticed, reaming and Lag Screw insertion should be done without K-Wire guidance.

The distal K-Wire, Recon and K-Wire Sleeve are left in place and another Tissue Protection Sleeve, assembled with the Drill Sleeve for the Solid Stepdrill, Recon (1806-3041) are inserted through the proximal hole of the Target Arm, Recon. The Ø6.5mm Solid Stepdrill for Lag Screw, Recon (1806-3026S) is forwarded through the Tissue Protection Sleeve and Drill Sleeve assembly and pushed onto the lateral cortex.

Reaming is performed under fluoroscopic control until the tip of the Solid Stepdrill for Lag Screw is just before the subchondral bone. The required length of the Lag Screw can be read directly off the Solid Stepdrill for Lag Screw, Recon at the end of the Drill Sleeve (Fig. 35a&b).

Using the Screwdriver, Recon (1806-3060), the correct Lag Screw is inserted through the Tissue Protection Sleeve and threaded up to the subchondral part of the femoral head. The screw is near its' proper seating position when the groove around the shaft of the screwdriver is approaching the end of the Tissue Protection Sleeve (Fig. 36&37).

The required length of the second Lag Screw can be measured using the Lag Screw Gauge, Recon.

Remove the Distal K-Wire, Recon and K-Wire Sleeve and insert the Sleeve for the solid Stepdrill into the distal Tissue Protection Sleeve.

Repeat the same surgical steps for drilling and insertion of the distal Lag Screw without K-Wire guidance.

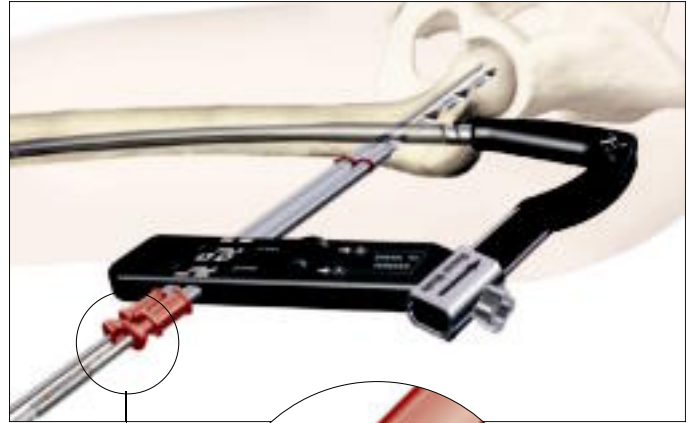

Fig. 35a

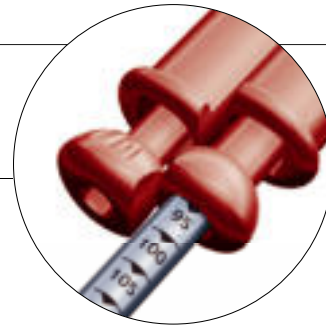

Fig. 35b

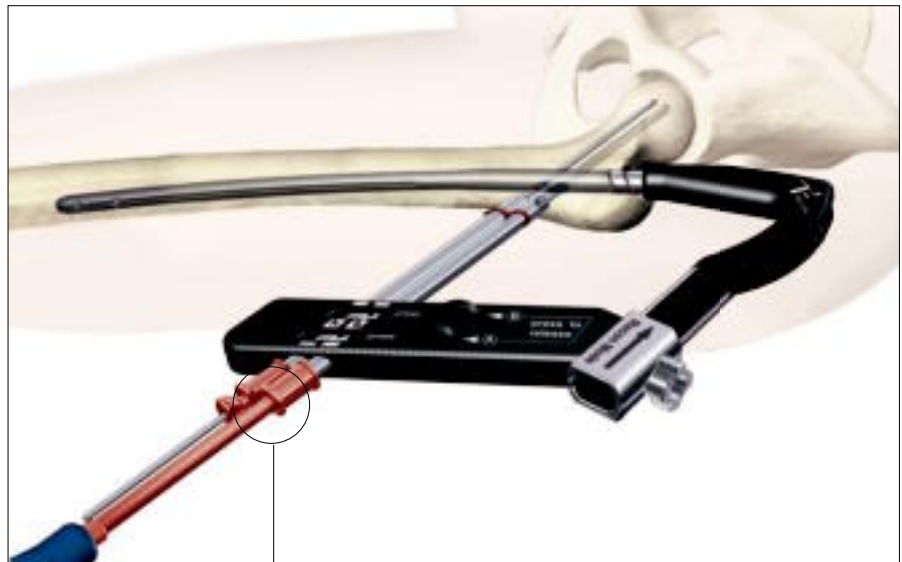

Fig. 36

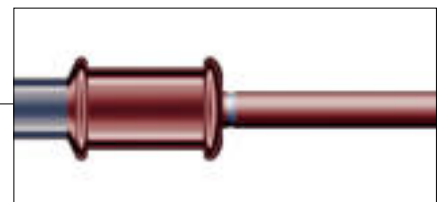

Fig. 37

Operative Technique

5.7.1. Guided Locking Mode for Antegrade Femoral Mode (via Target Device)

For standard Antegrade Femoral Mode, attach the Targeting Arm, Antegrade (1806-3003) onto the Nail Adapter, Recon (1806-3001). The Targeting Arm will sit in the groove positioned on the upper surface of the Nail Adapter because of an integrated spring locking mechanism which prevents sliding. A “click” will confirm correct positioning of the Targeting Arm. Tightening of the Locking Knob is mandatory for precise proximal locking (Fig. 38).



Fig. 38

Slide the Tissue Protection Sleeve, Long (1806-0185) together with the Drill Sleeve, Long (1806-0215) and the Trocar, Long (1806-0315) into the corresponding hole of the Targeting Arm, Antegrade (for Left or Right) by pressing the safety clip. The mechanism will keep the sleeve in place and prevent it from falling out. It will also prevent the sleeve from sliding during screw measurement. To release the Tissue Protection Sleeve, the Safety Clip must be pressed again.

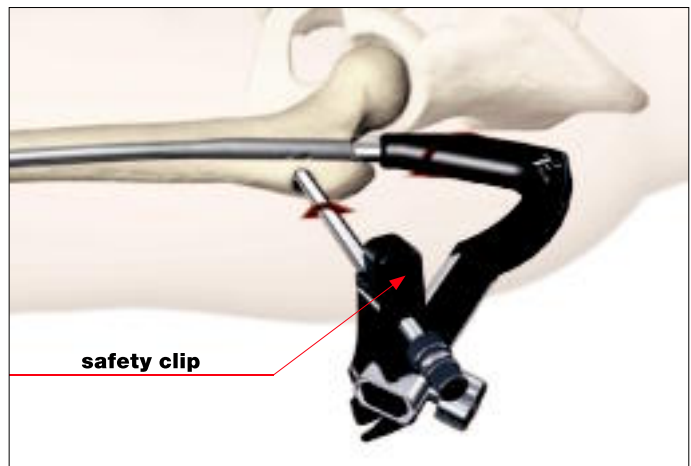

Fig. 39

A small skin incision is made and the assembly is pushed through until the Tissue Protection Sleeve is in contact with the lateral cortex (Fig. 39).

Note:

For optimal stability, the tip of the oblique screw should be positioned at the level of the Lesser Trochanter (Fig. 40).

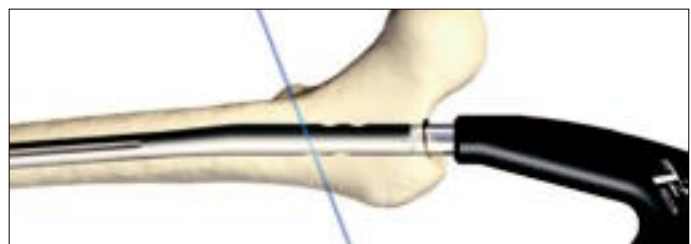

Fig. 40

Use the center-tipped, calibrated $\text{Ø}4.2 \times 340\text{mm}$ Drill (1806-4260S) and drill through both cortices (Fig. 41).

The screw length may be read directly from the Calibrated Drill, at the end of the Drill Sleeve (Fig. 42).



Fig. 42

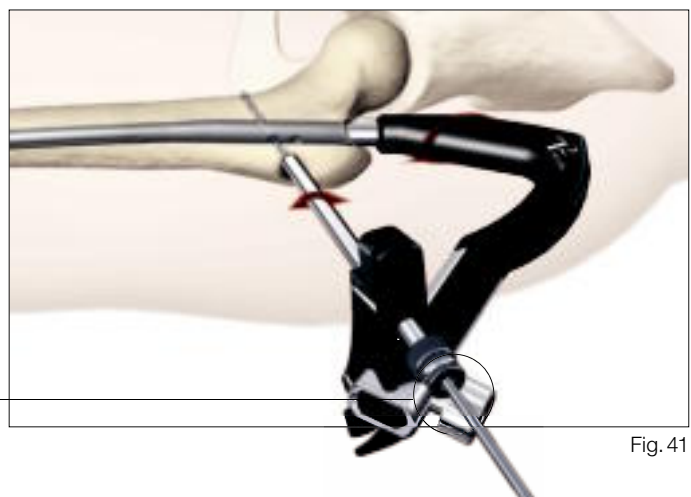

Fig. 41

Operative Technique

Note:

Start the drill before touching the bone and then keep gentle pressure on the first cortex to ensure accurate drilling.

Alternatively, to help ensure accurate drilling for the oblique screw, use the $\text{Ø}4.2 \times 250\text{mm}$ Drill (1806-8018S*) to open the first cortex. The Drill is forwarded through the Drill Sleeve and pushed onto the cortex. After opening the first cortex, use the center-tipped, calibrated $\text{Ø}4.2 \times 340\text{mm}$ Drill (1806-4260S) and drill through both cortices (Fig. 38 and 39).

Note:

The position of the end of the Drill, as it relates to the far cortex, is the same as where the end of the screw will be.

Therefore, if the end of the Drill is 3mm beyond the far cortex, the end of the screw will also be 3mm beyond (Fig. 43). Check the position of the end of Drill with image intensification before measuring the screw length.

If Screw measurement with the Screw Gauge, Long (1806-0325) is preferred, first remove the Drill Sleeve, Long and read the screw length directly at the end of the Tissue Protection Sleeve, Long.

Note:

The Screw Gauge, Long is calibrated so that with the bend at the end pulled back flush with the far cortex, the screw tip will end 3mm beyond the far cortex (Fig. 44).

When the Drill Sleeve is removed, the correct Locking Screw is inserted through the Tissue Protection Sleeve using the Long Screwdriver Shaft (1806-0227) with Teardrop Handle (702429) (Fig. 45). The screw is advanced through both cortices. The screw is near its' proper seating position when the groove around the shaft of the screwdriver is approaching the end of the Tissue Protection Sleeve (Fig. 46).

*Outside the U.S. products can be ordered also non sterile by eliminating the "S" at the end of the Ref. No.



Fig. 43



Fig. 44

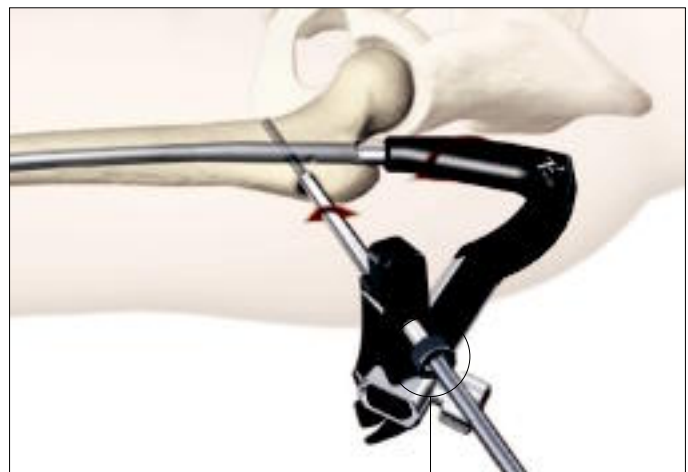

Fig. 45



Fig. 46

Operative Technique

5.8. Freehand Distal Locking

The freehand technique is used to insert Fully Threaded Locking Screws into both distal transverse holes in the nail.

Rotational alignment must be checked prior to locking the nail. This is performed by checking a lateral view at the hip and a lateral view at the knee. The anteversion should be the same as on the controlateral side.

Multiple locking techniques and radiolucent drill devices are available for freehand locking. The critical step with any freehand locking technique, proximal or distal, is to visualize a perfectly round locking hole with the C-Arm.

The center-tipped $\text{ø}4.2 \times 180$ Drill (1806-4270S)* or the $\text{ø}4.2 \times 230$ Drill (1806-4290S)* is held at an oblique angle to the center of the locking hole (Fig. 47). Upon X-Ray verification, the Drill is placed perpendicular to the nail and drilled through the lateral and medial cortex (Fig. 48). Confirm in both the A/P and Lateral views by X-Ray that the Drill passes through the hole in the nail.

After drilling both cortices, the screw length may be read directly off of the Long Screw Scale (1806-0365) at the green ring on the center-tipped 4.2×180 Drill (Fig. 49).

Alternatively, the Screw Gauge (1806-0480) for Freehand technique can be used instead of the Screw Scale, Long to determine the screw length.

Routine Locking Screw insertion is employed with the assembled Long Screwdriver Shaft and Teardrop Handle.

Note:

The Screwdriver Shaft can be used in conjunction with the Long Screw Capture Sleeve (1806-0240).

Repeat the locking procedure for the insertion of the second 5mm Fully Threaded Locking Screw into the oblong hole, in a static position (Fig. 50).

The **T2 Recon Nail** may be used in the **dynamic locking mode**. Only when

the fracture pattern permits, dynamic locking may be utilized for transverse, rotationally stable fractures. While dynamic locking can only be performed at the end of the nail, this will require a freehand distal targeting of the oblong hole in a dynamic posi-

tion. This allows the nail to move and the fracture to settle while torsional stability is maintained.

*Outside the U.S. products can be ordered also non sterile by eliminating the "S" at the end of the Ref. No.

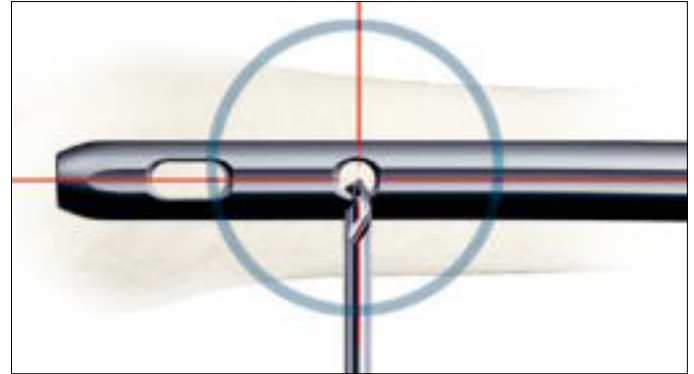
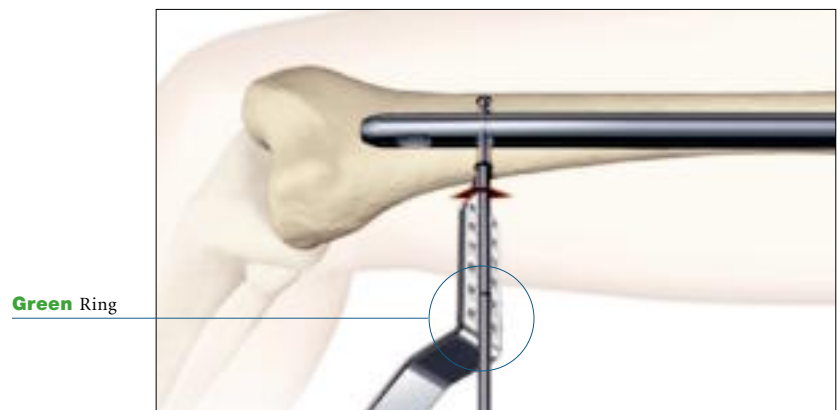

Fig. 47



Fig. 48



Green Ring

Fig. 49



Fig. 50

Operative Technique

5.9. Set Screw or End Cap Insertion

After removal of the Target Device, a Set Screw or End Cap can be used.

Two different Set Screws are available (Fig. 51a):

- a **Set Screw, Recon** to tighten down on the proximal Lag Screw (for the Recon Mode) and
- a **Set Screw, Antegrade** to tighten down on the oblique Fully Threaded Screw (for the Femoral Antegrade Mode).

Note:

If a Set Screw is used, an End Cap can no longer be inserted.

Four different sizes of End Caps are available to adjust nail length and to reduce the potential for bony ingrowth into the proximal thread of the nail (Fig. 51b).

The Set Screw or End Cap is inserted with the Long Screwdriver Shaft and Teardrop Handle after intra-operative radiographs confirm satisfactory reduction and hardware implantation (Fig. 52). Fully seat the End Cap or Set Screw to minimize the potential for loosening.

5.10. Nail Removal

Nail removal is an elective procedure. The Set Screw or End Cap is removed with Long Screwdriver Shaft and Teardrop Handle (Fig. 53).

The Universal Rod is inserted into the driving end of the nail. Alternatively, the Extraction Rod, conical (1806-0350), can be attached to the Universal Rod to facilitate extraction of the nail. All Locking Screws are removed with the Long Screwdriver Shaft and Teardrop Handle. The optional Long Screw Capture Sleeve (1806-0240) may be used on the Screwdriver Shaft. For removal of the Lag Screws, the Recon Screwdriver or the Recon Screwdriver Shaft and T-Handle are to be used.



Fig. 51a

Fig. 51b



Fig. 52



Fig. 53



Fig. 54

The Slotted Hammer is used to extract the nail in a controlled manner Fig. 54). A captured Sliding Hammer (1806-0175) is available as an optional addition to the dedicated instrument set.

Ordering Information - Implants

T2™ Recon Nail, Left



Titanium REF	Diameter mm	Length mm
1846-0934S	9.0	340
1846-0936S	9.0	360
1846-0938S	9.0	380
1846-0940S	9.0	400
1846-0942S	9.0	420
1846-0944S	9.0	440
1846-0946S	9.0	460
1846-0948S	9.0	480
1846-1134S	11.0	340
1846-1136S	11.0	360
1846-1138S	11.0	380
1846-1140S	11.0	400
1846-1142S	11.0	420
1846-1144S	11.0	440
1846-1146S	11.0	460
1846-1148S	11.0	480
1846-1334S	13.0	340
1846-1336S	13.0	360
1846-1338S	13.0	380
1846-1340S	13.0	400
1846-1342S	13.0	420
1846-1344S	13.0	440
1846-1346S	13.0	460
1846-1348S	13.0	480
1846-1534S	15.0	340
1846-1536S	15.0	360
1846-1538S	15.0	380
1846-1540S	15.0	400
1846-1542S	15.0	420
1846-1544S	15.0	440
1846-1546S	15.0	460
1846-1548S	15.0	480

T2™ Recon Nail, Right



Titanium REF	Diameter mm	Length mm
1847-0934S	9.0	340
1847-0936S	9.0	360
1847-0938S	9.0	380
1847-0940S	9.0	400
1847-0942S	9.0	420
1847-0944S	9.0	440
1847-0946S	9.0	460
1847-0948S	9.0	480
1847-1134S	11.0	340
1847-1136S	11.0	360
1847-1138S	11.0	380
1847-1140S	11.0	400
1847-1142S	11.0	420
1847-1144S	11.0	440
1847-1146S	11.0	460
1847-1148S	11.0	480
1847-1334S	13.0	340
1847-1336S	13.0	360
1847-1338S	13.0	380
1847-1340S	13.0	400
1847-1342S	13.0	420
1847-1344S	13.0	440
1847-1346S	13.0	460
1847-1348S	13.0	480
1847-1534S	15.0	340
1847-1536S	15.0	360
1847-1538S	15.0	380
1847-1540S	15.0	400
1847-1542S	15.0	420
1847-1544S	15.0	440
1847-1546S	15.0	460
1847-1548S	15.0	480

5mm Fully Threaded Locking Screws*



Titanium REF	Diameter mm	Length mm
1896-5025S	5.0	25.0
1896-5030S	5.0	30.0
1896-5035S	5.0	35.0
1896-5040S	5.0	40.0
1896-5045S	5.0	45.0
1896-5050S	5.0	50.0
1896-5055S	5.0	55.0
1896-5060S	5.0	60.0
1896-5065S	5.0	65.0
1896-5070S	5.0	70.0
1896-5075S	5.0	75.0
1896-5080S	5.0	80.0
1896-5085S	5.0	85.0
1896-5090S	5.0	90.0
1896-5095S	5.0	95.0
1896-5100S	5.0	100.0
1896-5105S	5.0	105.0
1896-5110S	5.0	110.0
1896-5115S	5.0	115.0
1896-5120S	5.0	120.0

6.5mm Lag Screws



Titanium REF	Diameter mm	Length mm
1897-6065S	6.5	65
1897-6070S	6.5	70
1897-6075S	6.5	75
1897-6080S	6.5	80
1897-6085S	6.5	85
1897-6090S	6.5	90
1897-6095S	6.5	95
1897-6100S	6.5	100
1897-6105S	6.5	105
1897-6110S	6.5	110
1897-6115S	6.5	115
1897-6120S	6.5	120
1897-6125S	6.5	125
1897-6130S	6.5	130

End Caps



Titanium REF	Diameter mm	Length mm
1822-0003S	8.0	Standard
1847-0005S	13.0	+ 5mm
1847-0010S	13.0	+10mm
1847-0015S	13.0	+15mm

Set Screws











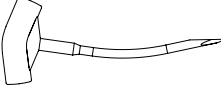

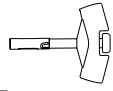

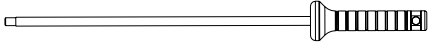
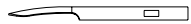

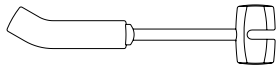
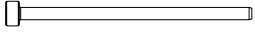

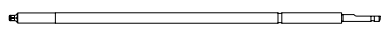
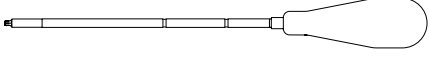
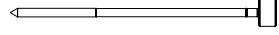

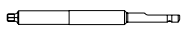
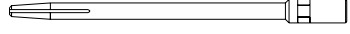
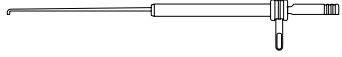
Titanium REF	Diameter mm	
1847-0003S	8.0	Set Screw, Antegrade
1847-0002S	8.0	Set Screw, Recon



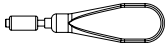

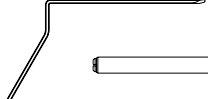





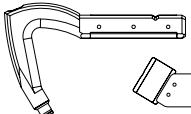

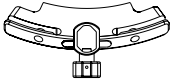

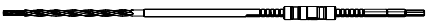

Implants are packed sterile

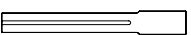
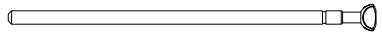
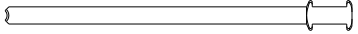
Outside of the U.S., Locking Screws may be ordered non-sterile without the "S" at the end of the corresponding Catalog Number.

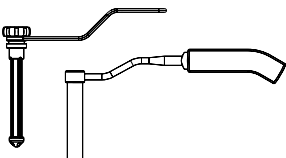
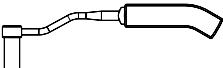
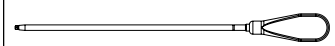
Ordering Information - Instruments

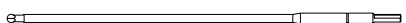
	REF	Description
Standard Instruments		
	1806-0040	Awl, Curved, Ø10mm
	1806-0041	Awl, Curved, Ø10mm, 90° Handle (optional, not stored on tray)
	1806-0032	Awl Plug (optional; not stored on tray)
	1806-0095	Guide Wire Handle
	1806-0096	Guide Wire Handle Chuck
	1806-0110	Universal Rod
	1806-0125	Reduction Spoon
	1806-0130	Wrench
	1806-0170	Slotted Hammer
	1806-0185	Tissue Protection Sleeve, Long
	1806-0215	Drill Sleeve, Long
	1806-0227	Screwdriver Shaft AO, Long
	1806-0232	Screwdriver, Long
	1806-0315	Trocar, Long
	1806-0325	Screw Gauge, Long
	1806-0292	Screw Driver Shaft, 3.5 x 85mm
	1806-0350	Extraction Rod, conical
	1806-0480	Screw Gauge, Femur
	1806-4260	Drill Ø4.2 x 340mm, AO
	1806-4270	Drill Ø4.2 x 180mm, AO
	1806-4290	Drill Ø4.2 x 230mm, AO
	702429	Teardrop Handle, AO Coupling
	702628	T-Handle, AO Medium Coupling
	1806-0365	Screw Scale, Long
	1806-0240	Screw Capture Sleeve, Long

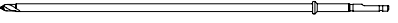
Ordering Information - Instruments

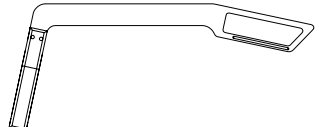
	REF	Description
Dedicated Instruments		
	1806-3001	Nail Adapter, Recon
	1806-3002	Targeting Arm, Recon
	1806-3003	Targeting Arm, antegrade
	1806-3005	Nail Holding Screw, Recon
	1806-1007	Fixation Screw
	1806-3010	One Step Conical Reamer Ø13, Recon
	1806-3015	One Step Conical Reamer Ø15, Recon
	1806-3025	Stepdrill for Lag Screw, Recon
	1806-3030	K-Wire, Recon
	1806-3035	Lag Screw Gauge, Recon
	1806-3040	K-Wire Sleeve, Recon (2 of each)
	1806-3045	Tissue Protection Sleeve, Recon (2 of each)
	1806-3050	Screw Driver Shaft, Recon
	1806-3055	Multi-hole Trocar
	1806-3057	Protection Sleeve, Antegrade
	1806-3060	Screw Driver, Recon
	1806-3070	K-Wire Inserter
	1806-3090	Screw Driver Shaft, AO, Ball Tip
	1806-3096	Strike Plate, Recon
	1806-8018	Drill Ø4.2×250mm, oblique, AO
	1806-3026S	Solid Stepdrill for Lag Screw, Recon
	1806-3041	Drill Sleeve for Solid Stepdrill
	1806-9400	Instrument Tray, empty
	1806-9410	Add-on Instrument Tray, empty
	1806-3080	X-Ray Template, Recon
	1213-3010	One Shot Device (optional, not stored on tray)

Ordering Information - Instruments

Bixcut™

Complete range of modular and fixed-head reamers to match surgeon preference and optimize O. R. efficiency, presented in fully sterilizable cases.

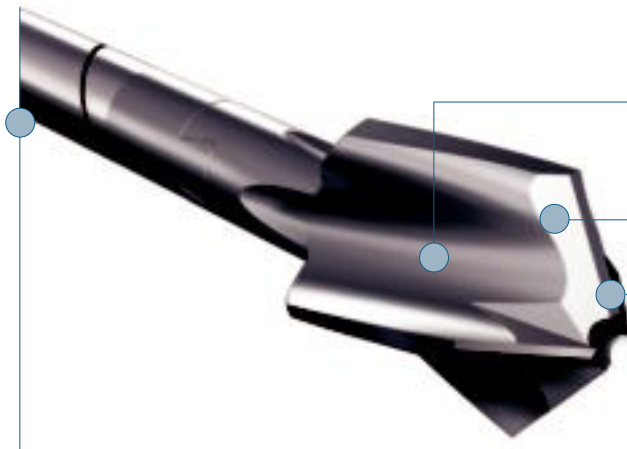

Large clearance rate resulting from reduced number of reamer blades coupled with reduced length of reamer head to give effective relief of pressure and efficient removal of material.

Cutting flute geometry optimized to lower pressure generation.

Forward- and side-cutting face combination produces efficient material removal and rapid clearance.

Double-wound shaft transmits torque effectively and with high reliability. Low-friction surface finish aids rapid debris clearance.

Smaller, 6 and 8mm shaft diameters significantly reduce IM pressure.

Typical Standard
Reamer Ø14mm

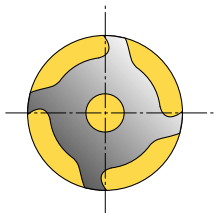

Clearance area:
32% of cross section

Bixcut™
Reamer Ø14mm

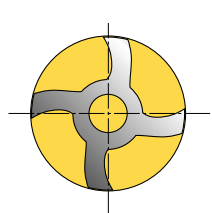

Clearance area:
59% of cross section

Recent studies¹ have demonstrated that the pressures developed within the medullary cavity through the introduction of unreamed IMnails can be far greater than those developed during reaming – but this depends very much upon the design of the reamer.

After a three year development study² involving several universities, the factors that determine the pressures and temperatures developed during reaming were clearly established. These factors were applied to the development of advanced reamers that demonstrate significantly better performance than the best of previous designs.

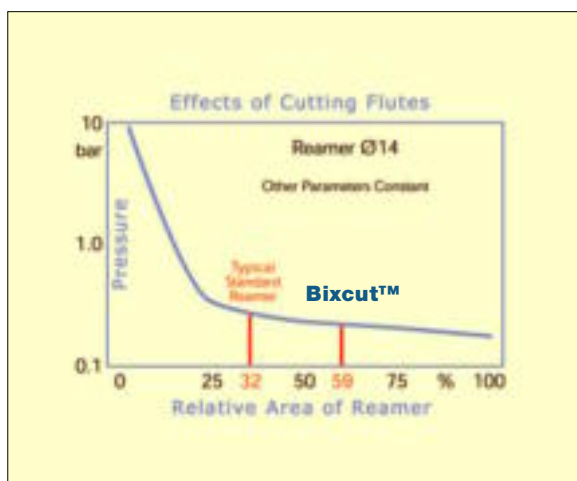

¹ Jan Paul M. Frolke, et al.; Intramedullary Pressure in Reamed Femoral Nailing with Two Different Reamer Designs., Eur. J. of Trauma, 2001 #5

² Mehdi Mousavi, et al.; Pressure Changes During Reaming with Different Parameters and Reamer Designs, Clinical Orthopaedics and Related Research Number 373, pp. 295-303, 2000

Ordering Information - Instruments

Bixcut™ Modular Head

REF	Description	Diameter mm
0226-3090	Bixcut Head	9.0
0226-3095	Bixcut Head	9.5
0226-3100	Bixcut Head	10.0
0226-3105	Bixcut Head	10.5
0226-3110	Bixcut Head	11.0
0226-3115	Bixcut Head	11.5
0226-3120	Bixcut Head	12.0
0226-3125	Bixcut Head	12.5
0226-3130	Bixcut Head	13.0
0226-3135	Bixcut Head	13.5
0226-3140	Bixcut Head	14.0
0226-3145	Bixcut Head	14.5
0226-3150	Bixcut Head	15.0
0226-3155	Bixcut Head	15.5
0226-3160	Bixcut Head	16.0
0226-3165	Bixcut Head	16.5
0226-3170	Bixcut Head	17.0
0226-3175	Bixcut Head	17.5
0226-3180	Bixcut Head	18.0
0226-4185	Bixcut Head	18.5
0226-4190	Bixcut Head	19.0
0226-4195	Bixcut Head	19.5
0226-4200	Bixcut Head	20.0
0226-4205	Bixcut Head	20.5
0226-4210	Bixcut Head	21.0
0226-4215	Bixcut Head	21.5
0226-4220	Bixcut Head	22.0
0226-4225	Bixcut Head	22.5
0226-4230	Bixcut Head	23.0
0226-4235	Bixcut Head	23.5
0226-4240	Bixcut Head	24.0
0226-4245	Bixcut Head	24.5
0226-4250	Bixcut Head	25.0
0226-4255	Bixcut Head	25.5
0226-4260	Bixcut Head	26.0
0226-4265	Bixcut Head	26.5
0226-4270	Bixcut Head	27.0
0226-4275	Bixcut Head	27.5
0226-4280	Bixcut Head	28.0

Bixcut™ Shaft – AO fitting (sterile)

REF	Description	Length mm
0226-3000(S)	Shaft, AO	450
0226-8240(S)	Shaft, AO	240

Bixcut™ Shaft – Modified Trinkle fitting (sterile)+

REF	Description	Length mm
0227-3000(S)	Shaft, Mod. Trinkle	450
0227-8240(S)	Shaft, Mod. Trinkle	240

Bixcut™ Trays

REF	Description
0225-6000	Tray, Modular Head (up to size 22.0mm)
0225-6001	Tray, Modular Head (up to size 28.0mm)
0225-8000	Tray, Fixed Head (up to size 18.0mm)

Bixcut™ Fixed Head – AO fitting

REF	Diameter mm	Length mm
0225-5060	6.0*	400
0225-5065	6.5*	400
0225-5070	7.0*	400
0225-6075	7.5	480
0225-6080	8.0	480
0225-6085	8.5	480
0225-6090	9.0	480
0225-6095	9.5	480
0225-6100	10.0	480
0225-6105	10.5	480
0225-6110	11.0	480
0225-8115	11.5	480
0225-8120	12.0	480
0225-8125	12.5	480
0225-8130	13.0	480
0225-8135	13.5	480
0225-8140	14.0	480
0225-8145	14.5	480
0225-8150	15.0	480
0225-8155	15.5	480
0225-8160	16.0	480
0225-8165	16.5	480
0225-8170	17.0	480
0225-8175	17.5	480
0225-8180	18.0	480

Bixcut™ Fixed Head – Modified Trinkle fitting+

REF	Diameter mm	Length mm
0227-5060	6.0*	400
0227-5065	6.5*	400
0227-5070	7.0*	400
0227-6075	7.5	480
0227-6080	8.0	480
0227-6085	8.5	480
0227-6090	9.0	480
0227-6095	9.5	480
0227-6100	10.0	480
0227-6105	10.5	480
0227-6110	11.0	480
0227-8115	11.5	480
0227-8120	12.0	480
0227-8125	12.5	480
0227-8130	13.0	480
0227-8135	13.5	480
0227-8140	14.0	480
0227-8145	14.5	480
0227-8150	15.0	480
0227-8155	15.5	480
0227-8160	16.0	480
0227-8165	16.5	480
0227-8170	17.0	480
0227-8175	17.5	480
0227-8180	18.0	480

+ Use with Stryker Power Equipment

* Use with 2.2mm × 800mm Smooth Tip and 2.5mm × 800mm Ball Tip Guide wires only.

Notes

Notes

