

T2™

Humeral Nailing System



Introduction

Contributing Surgeons :

Rupert Beickert, M.D.

Senior Trauma Surgeon
Murnau Trauma Center
Murnau
Germany

Rosemary Buckle, M.D.

Orthopaedic Associates, L.L.P.
Clinical Instructor
University of Texas Medical School
Houston, Texas
USA

Prof. Dr. med. Volker Bühren

Chief of Surgical Services
Medical Director of Murnau Trauma Center
Murnau
Germany

Michael D. Mason, D.O.

Assistant Professor of Orthopaedic Surgery
Tufts University School of Medicine
New England Baptist Bone & Joint Institute
Boston, Massachusetts
USA

This publication sets forth detailed recommended procedures for using Stryker Trauma devices and instruments.

It offers guidance that you should heed, but, as with any such technical guide, each surgeon must consider the particular needs of each patient and make appropriate adjustments when and as required.

A workshop training is required prior to first surgery.

Contents

1.	Introduction	4
1.1.	Implant Features	4
1.2.	Instrument Features	6
1.3.	References	6
2.	Indications	7
3.	Pre-operative Planning	7
4.	Locking Options	8
5.	Antegrade Technique	10
5.1.	Patient Positioning and Fracture Reduction	10
5.2.	Incision	10
5.3.	Entry Point	10
5.4.	Unreamed Technique	11
5.5.	Reamed Technique	11
5.6.	Nail Selection	12
5.7.	Nail Insertion	13
5.8.	Guided Locking Mode (via Target Device)	14
5.9.	Static Locking Mode	15
5.9.1.	Static Transverse Locking Mode	15
5.9.2.	Static Oblique Locking Mode	16
5.9.3.	Washer	16
5.10.	Freehand Distal Locking	17
5.11.	End Cap Insertion	18
5.12.	Dynamic Locking Mode	18
5.13.	Apposition/Compression Locking Mode	18
5.14.	Advanced Locking Mode	20
5.15.	Nail Removal	21
6.	Retrograde Technique	22
6.1.	Patient Positioning	22
6.2.	Incision	22
6.3.	Entry Point	23
6.4.	Unreamed Technique	23
6.5.	Reamed Technique	24
6.6.	Nail Selection	24
6.7.	Nail Insertion	24
6.8.	Guided Locking Mode (via Target Device)	26
6.9.	Static Locking Mode	27
6.9.1.	Static Transverse Locking Mode	27
6.9.2.	Static Oblique Locking Mode	28
6.9.3.	Washer	28
6.10.	Freehand Proximal Locking	29
6.11.	End Cap Insertion	30
6.12.	Dynamic Locking Mode	30
6.13.	Apposition/Compression Locking Mode	31
6.14.	Advanced Locking Mode	32
6.15.	Nail Removal	33
<hr/>		
	Ordering Information – Implants	34
	Ordering Information – Instruments	36

Introduction

1. Introduction

Over the past several decades **antegrade humeral nailing** has become the treatment of choice for most humeral shaft fractures. **Retrograde humeral nailing** has expanded the use of intramedullary nails.

Studies have shown the following benefits to be associated with Humeral Nailing:

Brief operative time (1)
Minimal morbidity (1)
Early return to function of the extremity (2)
In 90% of the cases, no external support is needed (1,2)
Closed technique (4)
Low infection rate (2,5,6)
Very good pain relief in stabilization of pathological fractures (2,4)

Compared to Plate and Screw Osteosynthesis:

Minimal damage to muscle, connective tissue and vasculature (1,3,7)
Reduced periosteal stripping and concomitant soft tissue damage (1)
Fewer radial nerve palsies (3,4)
Designed for load sharing instead of load bearing (2)
Cosmetically smaller incision

The T2™ Humeral Nailing System

is one of the first humeral nailing systems to offer an option for either an antegrade or a retrograde approach to repair fractures of the humerus.

One Implant, Two Approaches

Stryker Trauma has created a **new generation locking nail system**, bringing together all the capabilities and benefits of separate antegrade and retrograde nailing systems to create a **single, integrated surgical resource** for fixation of long-bone fractures.

Furthermore, the development of the T2™ Humeral Nailing System offers the competitive advantages of:

- **Dual nailing approach: Antegrade and Retrograde**
- **Accommodating reamed or unreamed procedures**
- **Static, controlled dynamic and apposition/compression locking options**
- **Advanced Locking Mode for increased rotational stability.**

Through the development of a common, streamlined and intuitive surgical approach, both in principle and in detail, the T2™ Humeral Nailing System offers **significantly increased speed and functionality** for the treatment of fractures as well as simplifying the training requirements for all personnel involved.

1.1. Implant Features

The T2™ Humeral Nailing System is the realization of superior biomechanical intramedullary stabilization.

The system offers the option of different locking modes:

- **Static, transverse/oblique**
- **Dynamic**
- **Apposition/compression**
- **Advanced locking**

In some indications, a **controlled apposition/compression of bone fragments can be applied by introducing a compression screw from the top of nail**. To further increase rotational stability, the nail can be locked after utilizing the apposition/compression feature.

The beneficial effect of apposition/compression in treating long-bone fractures in cases involving transverse

and short oblique fractures that are axially stable is well documented (15, 16, 19).

The **compression screw is pushed against the proximal Partially Threaded Locking Screw (Shaft Screw)** that has been placed in the oblong hole, **drawing either the distal or the proximal segment towards the fracture site**. In stable fractures, this has the biomechanical advantage of **creating active circumferential compression** to the fracture site, **transferring axial load to the bone**, and reducing the function of the nail as a load bearing device (17).

This ability to **transfer load back to the bone** can reduce the incidence of implant failure secondary to fatigue. Typical statically locked nails functioning as load bearing devices have reported failure rates in excess of 20% (18).

Common 4mm cortical screws simplify the surgical procedure. **Fully Threaded Locking Screws** are available for regular locking procedures. **Partially Threaded Locking Screws (Shaft Screws)** are designed for application of apposition/compression.

One **common Humeral Compression Screw** to close the fracture site, and **End Caps** in six sizes are available to provide a **“best fit” for every indication**.

All implants of the T2™ Humeral Nailing System are **cannulated, gun-drilled** and made of **Type II anodized titanium alloy (Ti6AL4V)** for **enhanced biomechanical and biomedical performance**.

See the **detailed chart on the next page** for the design specifications and size offerings.

Technical Details

Nails

Diameter 7–9mm
 Sizes 140–320mm



Humerus Advanced Compression Screw
 (Diameter = 6mm)



4.0mm Fully Threaded Locking Screws
 L = 20–60mm

4.0mm Partially Threaded Locking Screws
 (Shaft Screws)
 L = 20–60mm

End Caps



* Compression Range

Total Length of Slot	10mm
Less Screw Diameter (-)	4mm
Maximum Movement of Screw	6mm

Instrument Features

1.2. Instrument Features

The major advantage of the instrument system is a breakthrough in the integration of the instrument platform which can be used not only for the complete T2™ Nailing System, but will be the platform for all future nailing systems, thereby reducing complexity and inventory.

The instrument platform offers advanced precision and usability, and features ergonomically styled targeting devices.

In addition to the advanced precision and usability, the instruments are both color, number and symbol coded to indicate its usage during the surgical procedure.

Color and number coding indicates the step during the procedure in which the instrument is used. This color code system is marked on the trays to easily identify the correct instrument.

Step	Color	Number
Opening	Red	①
Reduction	Brown	②
Nail Introduction	Green	③
Guided Locking	Light Blue	④
Freehand Locking	Dark Blue	⑤

Symbol coding on the instruments indicates the type of procedure, and must not be mixed.

Symbol

- Square = Long instruments, Femur
- ▲ Triangular = Short instruments, Tibia and Humerus

Drills

Drills feature color coded rings :

3.5mm = **Orange**
 For 4.0mm Fully Threaded Locking Screws and for the second cortex when using 4.0mm Partially Threaded Locking Screws (Shaft Screws).

4.0mm = **Grey**
 For the first cortex when using 4.0mm Partially Threaded Locking Screws (Shaft Screws).

1.3. References

1. J. Blum et al., Unreamed Humeral Nails Prove Reliable, Safe in Multicentre Study, International Edition Orthopaedics Today, Volume 1 Number 2, March/April 1998.
2. B. Redmond et al., Interlocking Intramedullary Nailing of Pathological Fractures of the Shaft of the Humerus, The Journal of Bone and Joint Surgery, Vol. 78-A, No. 6, June 1996.
3. P. Rommens et al., Die Verriegelungsnagelung der Humerusschaftfraktur. Eine kritische Bewertung von 100 Fällen, Swiss Surg. Suppl. 2/1996, p. 7
4. P. Rommens et al., Retrograde Verriegelungsnagelung der Humerusschaftfraktur. Eine klinische Studie, Unfallchirurg, 1995, 98 pp. 133–138.
5. The Unreamed Nail – A Biological Osteosynthesis of the upper arm Acta Chir. Belg. 1997 August; 97(4) : 184–189.
6. J. Stapert et al., Behandlung von Humerusschaftfrakturen mit dem TLN (Telescopic Locking Nail), Swiss Surg. Suppl. 2/1996, p.
7. D. Wheeler, M. Colville, Biomechanical Comparison of Intramedullary and Percutaneous Pin Fixation for Proximal Humeral Fracture Fixation, Journal of Orthopaedic Trauma, Vol. 11, No. 5, pp. 363–367.
8. ASTM Designation: F138–92, Standard Specification for Wrought Titanium 6A I–4V ELI Alloy for Surgical Implant Applications.
9. ASTM Designation: F138–92, Standard Specification for Stainless Steel Bar and Wire for Surgical Implants (Special Quality).
10. Leventhal G., Journal of Bone and Joint Surgery, Vol 33–A, No 2, April 1951, p475.
11. Bothe RT, Beaton KE, Davenport HA (1940) Reaction of Bone to Multiple Metallic Implants, Surg. Gynaecol. Obstet. 71, 598.
12. Bardos DI, "Titanium and Titanium Alloys", in D. Williams (ed.) Concise encyclopedia of medical and dental materials, Pergamon Press, Oxford, 1990, 360–365.
13. Solar R.: Corrosion Resistance of Titanium Surgical Implant Alloys: A Review, in Corrosion and Degradation of Implant Materials, ASTM STP 684, American Society for Testing and Materials, 1979, pp 259–273.
14. AO/ASIF Titanium – 6% Aluminum – 7% Niobium Implant Material, AO/ASIF Materials Technical Commission, First Edition June 1993.
15. Müller ME, et al Manual for Internal Fixation. Springer-Verlag Berlin, 1991.
16. O. Gonschorek, G. O. Hofmann, V. Bühren, Interlocking Compression Nailing: A report on 402 Applications, Arch Orthop Trauma Surg (1998) 117: 430–437.
17. T. E. Richardson, M. Voor, D. Seligson, Fracture Site Compression and Motion with Three Types of Intramedullary Fixation of the Femur, In: Osteosynthese International (1998), 6: 261–264.
18. Hutson et al., Mechanical Failures of Intramedullary Tibial Nails Applied without Reaming, In: Clin. Orthop. (1995), 315: 129–137.
19. Bühren V. Kompressionsnagelung langer Röhrenknochen, Unfallchirurg 103,2000, 708–720.
20. Mehdi Mousavi, et al., Pressure Changes During Reaming with Different Parameters and Reamer Designs, Clinical Orthopaedics and Related Research, Number 373, pp.295–303, 2000.

Indications

2. Indications

The T2™ Humeral Nail is indicated for:

- Fractures of the shaft
- Non-unions
- Malalignments
- Pathological fractures
- Impending pathologic fractures

Fractures situated between the proximal one sixth and the distal one fourth of the humerus are considered appropriate for nailing.

3. Pre-operative Planning

An X-Ray Template is available for pre-operative planning.

Thorough evaluation of pre-operative radiographs of the affected extremity is critical. Careful radiographic examination can help prevent intra-operative complications.

If X-Rays show a very narrow intramedullary canal in the distal part of the humerus, retrograde humeral nailing is not possible.

The proper nail length when inserted antegrade should extend from subchondral bone proximally, to 1cm above the olecranon fossa distally.

The retrograde nail length is determined by measuring the distance from 1cm above the olecranon fossa to the center of the humeral head.

In either approach, the surgeon should consider the apposition/compression feature of the T2™ Humeral Nail, knowing that 6mm of active apposition/compression is possible, prior to determining the final length of the implant.

Note:

Check with local representative regarding availability of nail sizes.

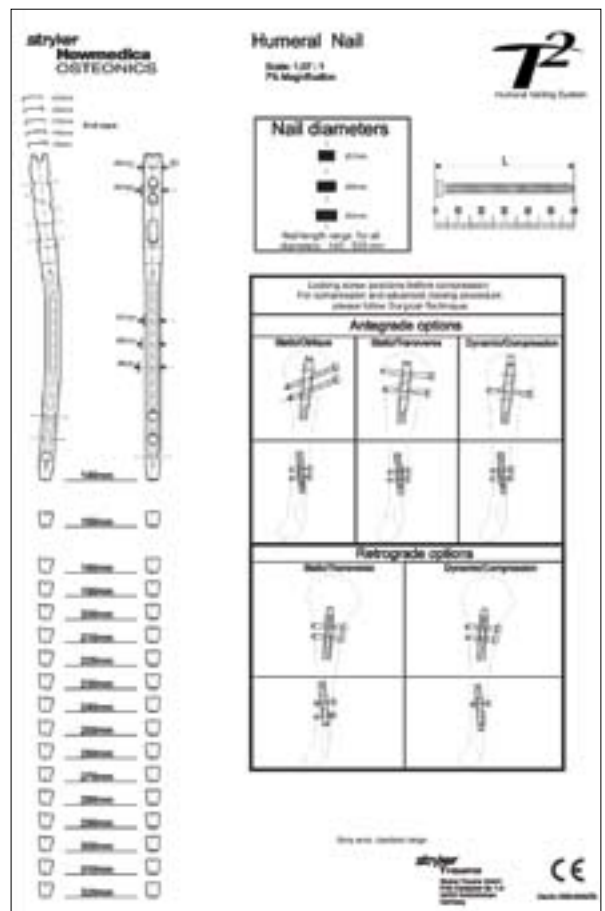

Locking Options

4. Locking Options

Antegrade



Static Mode transverse

Static Mode oblique

Retrograde

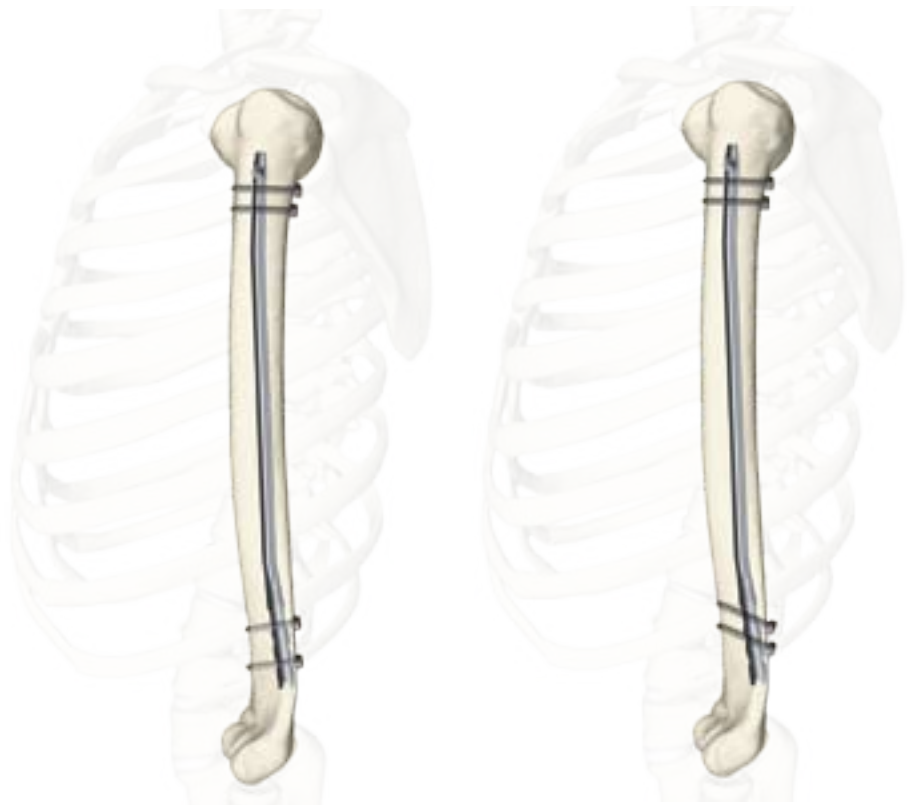

Locking Options



Dynamic Mode



Apposition/Compression Mode



Advanced Locking Mode



Antegrade Technique

5. Antegrade Technique

5.1. Patient Positioning and Fracture Reduction

The patient is placed in a semi-reclined “beach chair position” or supine on a radiolucent table. Patient positioning should be checked to ensure that imaging and access to the entry site are possible without excessive manipulation of the affected extremity (Fig. 1). The image intensifier is placed at the legside of the patient; the surgeon is positioned at the headside.

5.2. Incision

A small incision is made in line with the fibers of the deltoid muscle anterolateral to the acromion. The deltoid is split to expose the subdeltoid bursa. Palpate to identify the anterior and posterior margins of the greater tuberosity and supraspinatus tendon. The supraspinatus tendon is then incised in line with its fibers (Fig. 2).

The real rotation of the proximal fragment is checked (inversion or reversion), considering that the entry point is at the tip of the greater tubercle. If the proximal fragment is inverted, the entry point is more anterior. If the proximal fragment is in external rotation, the entry point is more lateral. It is recommended to localize the entry point under image intensifier control, also palpating the bicipital groove, the portal is about 10mm posterior to the biceps tendon. This will make the entry portal concentric to the medullary canal.



Fig. 1



Fig. 2

5.3. Entry Point

The entry point is made with the Curved, cannulated Awl (1806-0040) (Fig. 3). The 2.5 × 800mm Ball Tip Guide Wire (1806-0083S) is then introduced through the awl under image intensification into the meta-physis, central to the long axis of the humerus.

Alternatively, the 3 × 285mm K-Wire (1806-0050S) is introduced under image intensification into the meta-physis, central to the long axis of the humerus.

The cannulated Ø10mm Rigid Reamer (1806-2010) may be used over the K-Wire and the proximal metaphysis should be drilled to a depth of at least 6cm.

Note:

During opening the entry portal with the Awl, dense cortex may block the tip of the Awl. An Awl Plug (1806-0032) can be inserted through the Awl to avoid penetration of bone debris into the cannulation of the Awl shaft.



Fig. 3

Antegrade Technique

5.4. Unreamed Technique

If an unreamed technique is preferred, the nail may be inserted over the 2.2×800mm Smooth Tip Guide Wire (1806-0093S) (Fig. 4).



Fig. 4

5.5. Reamed Technique

For reamed techniques, the 2.5×800mm Ball Tip Guide Wire (1806-0083S) is inserted across the fracture site. The Reduction Rod (1806-0363), or the Universal Rod, Long with the Reduction Spoon (both optional), may be used as a fracture reduction tool to facilitate Guide Wire insertion across the fracture site (Fig. 5).

Reaming is commenced in 0.5mm increments until cortical contact is appreciated. Final reaming should be 1mm–1.5mm larger than the diameter of the nail to be used.

Note:

The driving end of 7mm nails is 8mm.

When reaming is completed, the Teflon Tube (1806-0073S) should be used to exchange the Ball Tip Guide Wire with the Smooth Tip Guide Wire for nail insertion (Fig. 6 and Fig. 7).

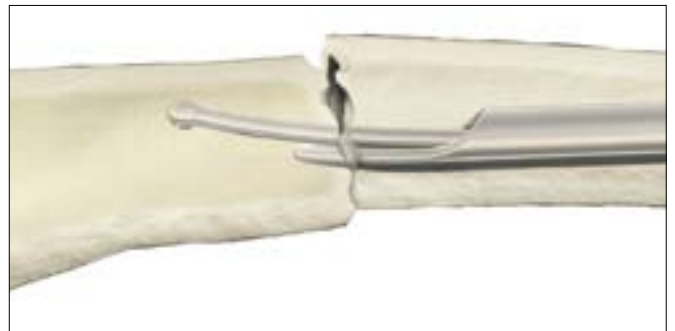

Fig. 5



Fig. 6



Fig. 7

Antegrade Technique

5.6. Nail Selection

The X-Ray Template should be used pre-operatively to determine the canal size radiographically. This information may be utilized in conjunction with the clinical assessment of canal size as determined by the size of the last reamer used.

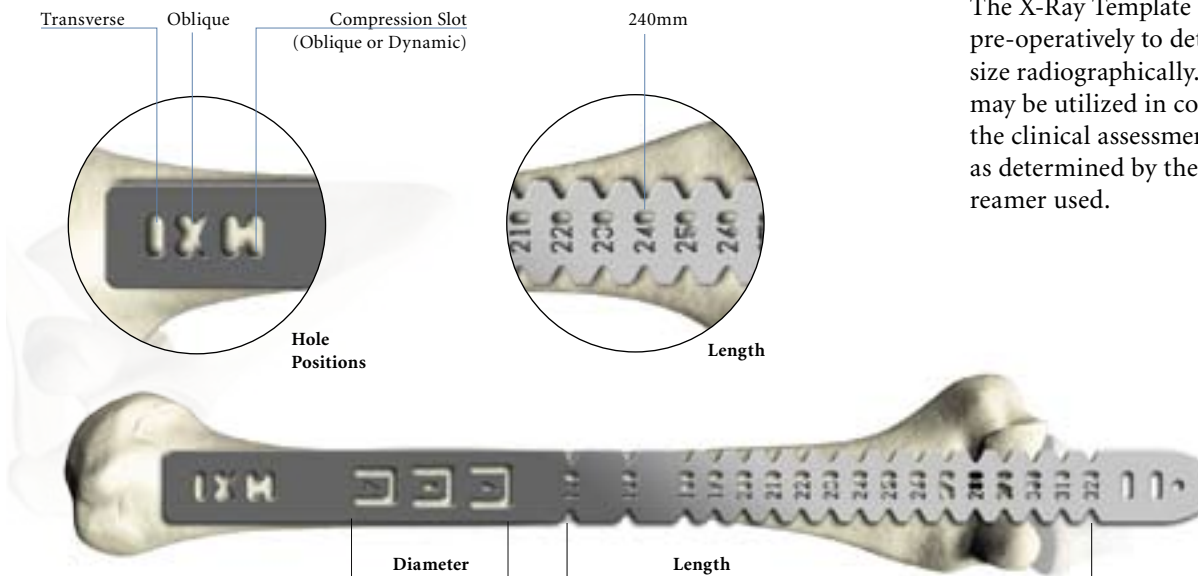

Fig.8

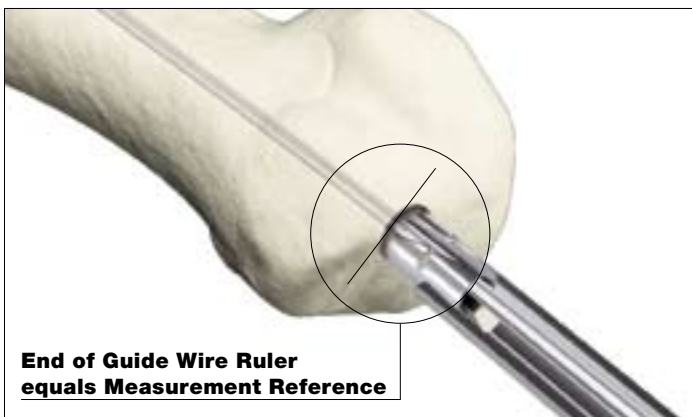

Fig.9

Diameter

The diameter of the selected nail should be 1mm–1.5mm smaller than the last reamer used.

Length

Nail length may be determined with the X-Ray Ruler (Fig. 8). The Guide Wire Ruler (1806-0020) may be used by placing it on the Guide Wire reading the correct nail length at the end of the Guide Wire on the Guide Wire Ruler (Fig. 9 and Fig. 10). Confirm the position of the tip of the Guide Wire prior to measurement.

Note:

If the fracture is suitable for apposition/compression, the implant selected should be 6–10mm shorter than measured to help avoid migration of the nail beyond the insertion site.

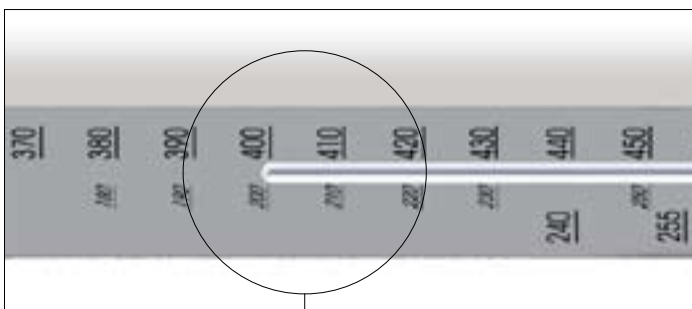

Fig.10



Antegrade Technique

5.7. Nail Insertion

The selected nail is assembled onto the Target Device (1806-0143) with the Nail Holding Screw (1806-0163). Tighten the Nail Holding Screw securely with the Insertion Wrench (1806-0135) so that it does not loosen during nail insertion (Fig. 11).



Fig. 11

Note:

Prior to nail insertion please check correct alignment by inserting a drill bit through the assembled Tissue Protection- and Drill Sleeve placed in the required holes of the targeting device.

Upon completion of reaming and Guide Wire exchange, the appropriate size nail is ready for insertion. Advance the nail through the entry point past the fracture site to the appropriate level.



Fig. 12



Fig. 13

Gentle rotation of the nail may be necessary to start the nail insertion. The nail should be advanced with manual pressure. Aggressive use of the slotted hammer can result in additional fractures. If the nail does not advance easily, a check with image intensification should be made to see if the nail angle is too steep resulting in the nail impinging on the medial cortex.

The Slotted Hammer (1806-0170) can be used to insert the nail over the Guide Wire. Do not hit the Target Device.

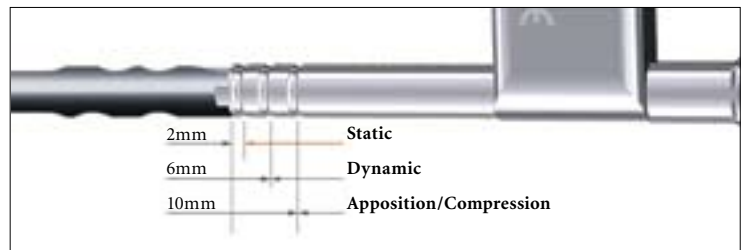

Fig. 14

Note:

A chamfer is located on the working end of the nail to denote the end under X-ray. Three circumferential grooves are located on the insertion post at 2mm, 6mm, and 10mm from the driving end of the nail (Fig. 12–14). Depth of insertion may be visualized with the aid of fluoroscopy.

The 3 × 285mm K-Wire may be inserted through the Target Device which identifies the junction of the nail and insertion post (Fig. 15).



Fig. 15

Antegrade Technique

5.8. Guided Locking Mode (via Target Device)

Prior to guided locking via the Target Device, the Nail Holding Screw must be firmly tightened using the Insertion Wrench, to ensure that the nail is in correct alignment with the Target Device.

The Target Device is designed to provide **four options for guided locking** (Fig. 16.1–16.4).

In the **Static Oblique Locking Mode**, the two static holes closest to the end of the nail may be used for static oblique (30°) locking (Fig. 16.1).

- 1. Static**
- 2. Static**

In the **Static Transverse Locking Mode**, the next static hole and the dynamic hole are used for static transverse locking (Fig. 16.2).

- 3. Static**
- 4. Dynamic**

In the **Controlled Dynamic Mode**, and/or **Controlled Apposition/Compression Mode**, the dynamic hole is required (Fig. 16.3).

- 4. Dynamic**

In the **Advanced Locking Mode**, the dynamic hole is required. After utilizing compression with the Advanced Compression Screw, the static hole is used (Fig. 16.4).

- 4. Dynamic**
- 3. Static**

The Short Tissue Protection Sleeve, (1806-0180), together with the Short Drill Sleeve (1806-0210) and the Short Trocar (1806-0310), are inserted into the Target Device by pressing the safety clip (Fig. 17).

The **friction lock mechanism** is designed to keep the sleeve in place and prevent it from falling out. It is designed to also keep the sleeve from sliding during screw measurement. To release the Tissue Protection Sleeve, the safety clip must be pressed again.



Fig.16.1



Fig.16.2



Fig.16.3



Fig.16.4

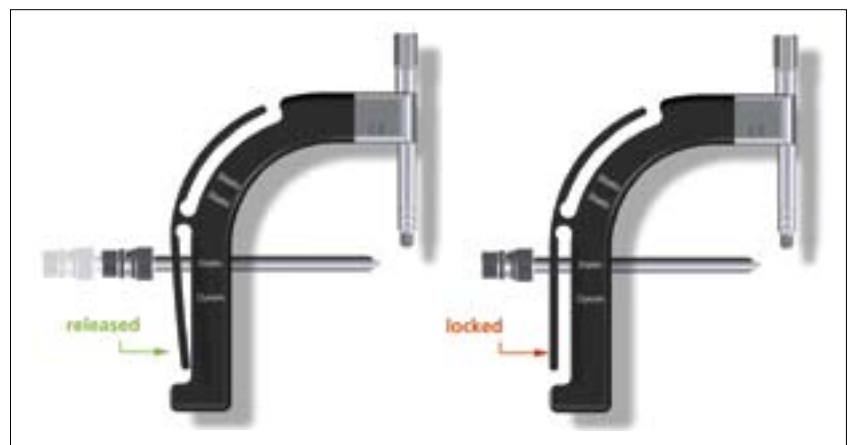

Fig.17

Antegrade Technique

5.9. Static Locking Mode

5.9.1. Static Transverse Locking Mode

In unstable or comminuted fractures, the nail should be used as a standard interlocking nail. Static locking of the distal holes will help maintain the length of the nail and the rotational stability of the fracture.

The Short Tissue Protection Sleeve, together with the Short Drill Sleeve and the Short Trocar, are positioned through the static locking hole on the Target Device. A small skin incision is made, and the assembly is pushed through until it is in contact with the lateral cortex of the humerus (Fig.18).

Note:

Especially in the proximal humerus, use image intensification to help ensure the Tissue Protection Sleeve is flush with the cortex or you could lose 1–2mm of screw measurement accuracy.

The Trocar is removed while the Tissue Protection Sleeve and the Drill Sleeve remain in position.

For accurate drilling and easy determination of screw length, use the center-tipped, $\text{Ø}3.5 \times 230\text{mm}$ calibrated Drill (1806-3540S). The centered Drill is forwarded through the Drill Sleeve and pushed onto the cortex. After the first cortex is drilled to the appropriate level the screw length may be read directly off of the Drill at the end of the Drill Sleeve (Fig. 19).

Note:

Do not drill through the far cortex as this will penetrate the joint.

Note:

The position of the end of the Drill as it relates to the far cortex is equal to where the end of the screw will be. Therefore, if the end of the Drill is 3mm beyond the far cortex, the end of the screw will also be 3mm beyond.



Fig. 18

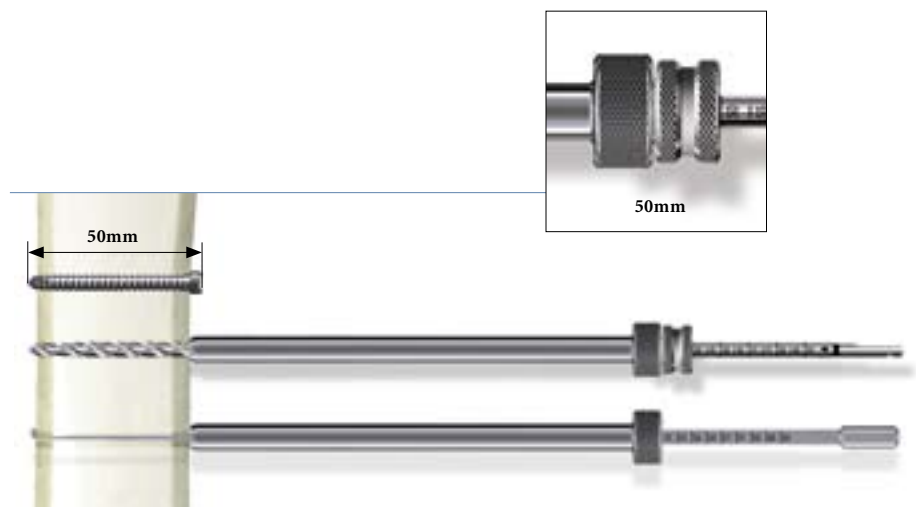

Fig. 19

Note:

The Screw Gauge, Short, is calibrated so that with the bend at the end pulled back flush with the far cortex, the screw tip will end 3mm beyond the far cortex (Fig. 19).

When the Drill Sleeve is removed, the correct 4.0mm Locking Screw is inserted through the Tissue Protection Sleeve using the Screwdriver Shaft, Short (1806-0222) with the Teardrop Handle (702429, Fig. 20). The screw is near its' proper seating position when the groove around the shaft of the screwdriver is approaching the end of the Tissue Protection Sleeve.

Use image intensification to confirm screw position through the nail as well as screw length.

Repeat the locking procedure for the other statically positioned Locking Screw (Fig. 21).



Fig. 20

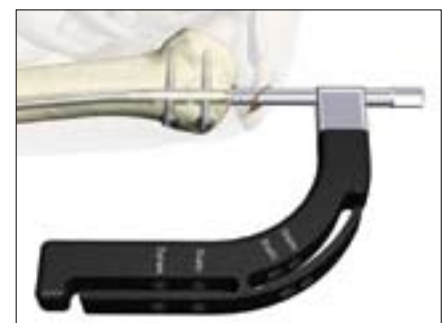

Fig. 21

Antegrade Technique

5.9.2. Static Oblique Locking Mode

In cases that may be locked in the Static Oblique Locking Mode, place the assembly of the Tissue Protection Sleeve together with the Drill Sleeve and the Trocar through the Oblique static hole closest to the driving end of the nail (Fig. 22). Refer to the procedure described in 5.9.1. for Locking Screw insertion.

The second Fully Threaded Locking Screw is inserted through the static hole (Fig. 23) next to the first hole, and placed in an oblique manner through the oblong hole of the nail (Fig. 24).

Confirm screw position and screw length with image intensification.

5.9.3. Washer

The Washer, either Rectangular or Round, may be used in cases of osteoporotic bone to bridge the bone gap and allow for enhanced purchase of the Locking Screw (Fig. 25).



Fig. 25



Fig. 22



Fig. 23



Fig. 24

Antegrade Technique

5.10. Freehand Distal Locking

The freehand technique is used to insert Locking Screws into both the A/P and M/L holes in the nail. Rotational alignment must be checked prior to distal locking.

Multiple locking techniques and radio-lucent drill devices are available for freehand locking. The critical step with any freehand locking technique, proximal or distal, is to visualize a perfectly round locking hole with the C-Arm.

Note:

In order to avoid damage to the neurovascular structure, a limited open approach should be considered.

The center-tipped $\text{Ø}3.5 \times 230\text{mm}$ Drill (1806-3540S), or the optional $\text{Ø}3.5 \times 130\text{mm}$ Drill (1806-3550S), is held at an oblique angle to the center of the locking hole (Fig. 26, 27). Upon X-Ray verification, the Drill is placed perpendicular to the nail and drilled through the anterior cortex. Confirm these views in both the A/P and M/L planes by X-Ray.

After drilling both cortices, the screw length may be read directly off of the Screw Scale, Short (1806-0360) at the orange color coded ring on the center-tipped Drill (Fig. 28). As with proximal locking (Fig. 19, p.15), the position of the end of the drill is equal to the end of the screw as they relate to the far cortex.

Routine Locking Screw insertion is employed with the assembled Short Screwdriver Shaft and the Teardrop Handle.

If possible, the distal humerus should be locked with two Fully Threaded Locking Screws. Additional locking of the M/L hole(s) is possible if the image intensifier can be adjusted (Fig. 29).

Note:

Use image intensification to confirm screw position through the nail as well as screw length.



Fig. 26

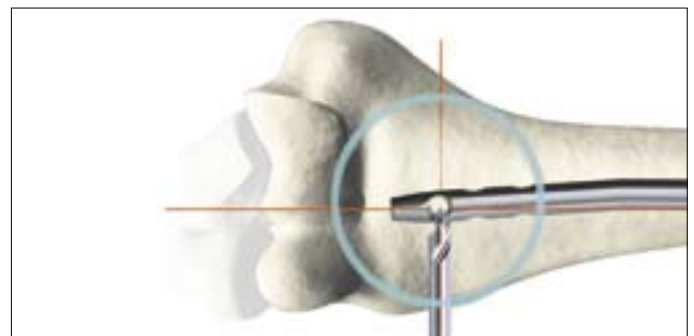

Fig. 27

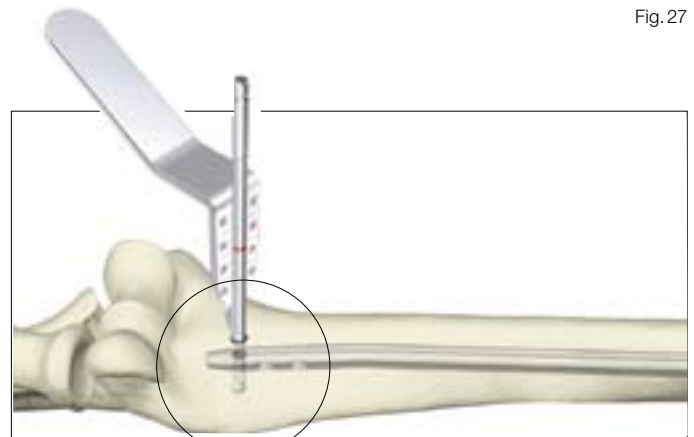

Fig. 28

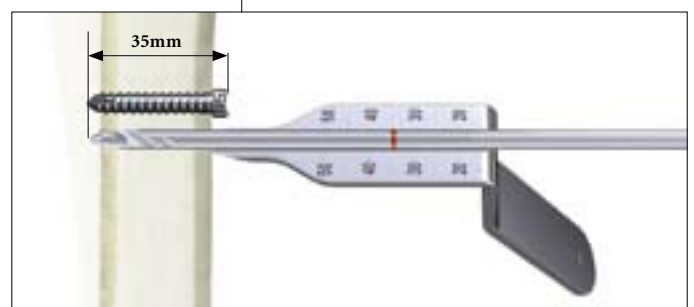

Fig. 28a



Fig. 29

Antegrade Technique

5.11. End Cap Insertion

After removal of the Target Device, an End Cap is used to reduce the potential for bony ingrowth into the proximal threads of the nail.

End Caps are available in six sizes (Fig. 30).

The End Cap is inserted with the Short Screwdriver Shaft assembled on the Teardrop Handle after intra-operative radiographs show satisfactory reduction and hardware implantation (Fig. 31). Fully seat the End Cap to minimize the potential for loosening.

Note:

To avoid impingement, carefully select the length of the End Cap.

Close the wound using standard technique.



Fig.30

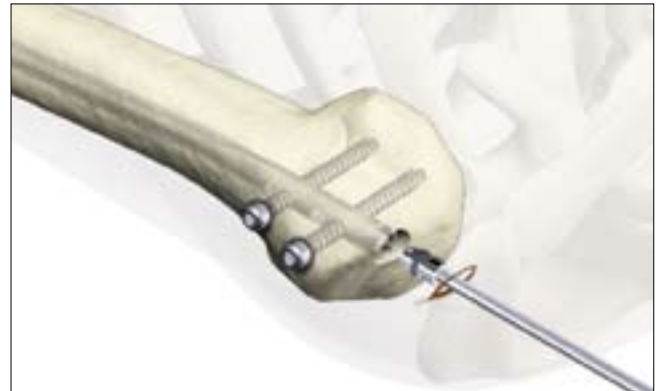

Fig.31

5.12. Dynamic Locking Mode

When the fracture profile permits, controlled dynamic locking may be utilized for transverse or axially stable fractures.

Antegrade dynamization is performed by statically locking the nail distally.

The guided Partially Threaded Locking Screw (Shaft Screw) is then placed in the dynamic position of the oblong hole. This allows the nail to move, and the fracture to settle while torsional stability is maintained (Fig. 32).

5.13. Apposition/Compression Locking Mode

In transverse or axially stable fracture patterns, active apposition/compression increases fracture stability and enhances fracture healing. The antegrade T2™ Humeral Nail provides the option to treat a humerus fracture with active mechanical apposition/compression prior to leaving the operating room.

Note:

Distal freehand static locking must be performed prior to applying active, controlled apposition/compression to the fracture site.

If active apposition/compression is required, a Partially Threaded Locking Screw (Shaft Screw) is inserted via the Target Device in the dynamic position of the oblong hole. This will allow for a maximum of 6mm of active, controlled apposition/compression. In order to insert the Partially Threaded Locking Screw (Shaft Screw), drill both cortices with the Ø3.5×230mm Drill (1806-3540S). Next, **the near cortex ONLY is overdrilled** with the Ø4.0×180mm Drill (1806-4000S).

Fig.32

Antegrade Technique

Note:

After the opposite cortex is drilled with the $\text{Ø}3.5 \times 230\text{mm}$ drill, the correct screw length can be read directly off of the calibrated Drill at the end of the Drill Sleeve.

After the Partially Threaded Locking Screw (Shaft Screw) is inserted, the Nail Holding Screw is removed, leaving the insertion post intact with the nail (Fig. 33). This will act as a guide for the Compression Screw. The Compression Screw with the Compression Screwdriver Shaft (1806-0263) assembled on the Teardrop Handle is inserted through the insertion post (Fig. 34).

Note:

It may be easier to “insert” the Compression Screw prior to fully seating the nail. Once the nail tip has cleared the fracture site, the Guide Wire (if used) is withdrawn. With the proximal portion of the nail not fully seated and extending out of the bone, the Advanced Compression Screw is inserted. Care should be taken that the shaft of the Compression Screw does not extend into the area of the oblong hole.

The Short Tissue Protection Sleeve is removed and the Compression Screw is gently tightened utilizing the two-finger technique (Fig. 35). As the Compression Screw is advanced against the 4.0mm Partially Threaded Locking Screw (Shaft Screw), it draws the distal fracture segment towards the fracture site, employing active apposition/compression (Fig. 36). Image intensification will enable the surgeon to visualize active apposition/compression. Some bending of the transverse Partially Threaded Locking Screw (Shaft Screw) may be seen.

Note:

Apposition/compression must be carried out under X-Ray control. Over compression may cause the nail or the Partially Threaded Locking Screw (Shaft Screw) to fail.

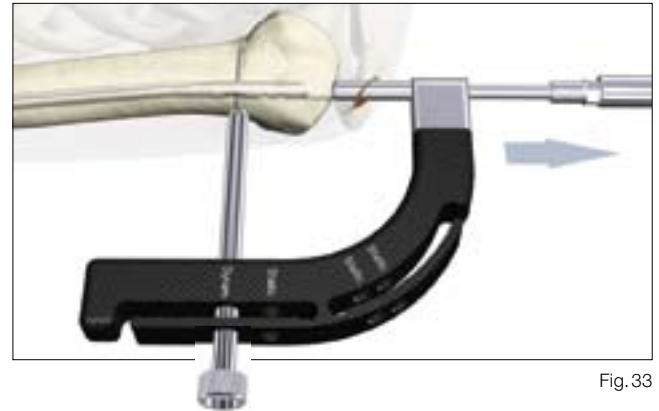

Fig. 33

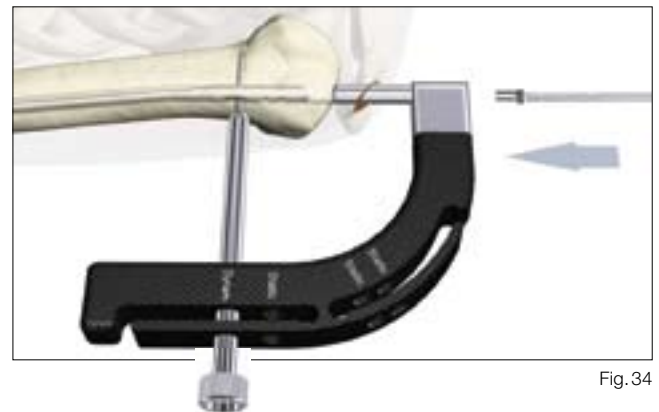

Fig. 34

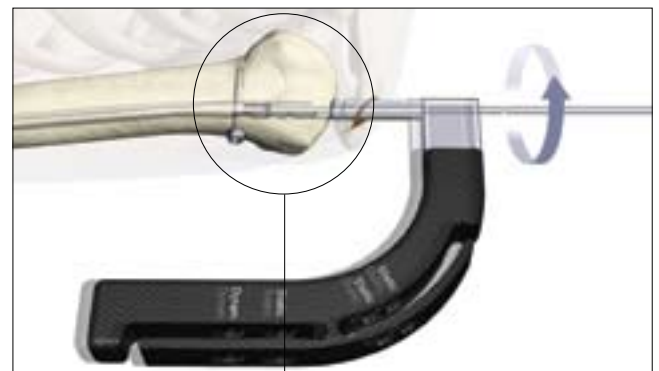

Fig. 35

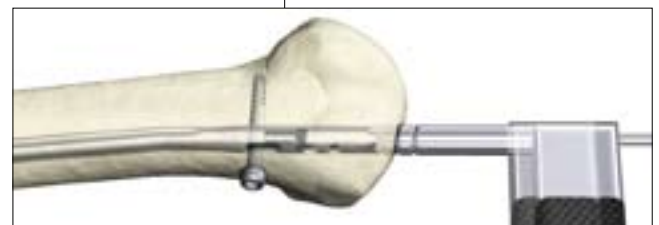

Fig. 36

Note:

When compressing the nail, the implant must be inserted a safe distance from the entry point to accommodate for the 6mm of active compression. The three grooves on the insertion post are designed to help attain accurate insertion depth of the implant.

Antegrade Technique

5.14. Advanced Locking Mode

In order to achieve additional fixation and to reduce the load on the Partially Threaded Locking Screw (Shaft Screw), the design of the T2™ Humeral Nail provides the opportunity to insert a Fully Threaded Locking Screw in the other transverse hole at the driving end of the nail after apposition/compression is utilized.

Prior to guided locking via the Target Device, the Nail Holding Screw must be tightened using the Insertion Wrench.

Fix the Advanced Compression Screw on the self-retaining Compression Screwdriver Shaft. Remove the Nail Holding Screw leaving the Target Device in place (Fig. 37). Advance the Compression Screw through the Target Device until the desired amount of compression is achieved. Visualize depth of insertion with the aid of fluoroscopy (Fig. 38).

Note:

As previously described, it may be easier to insert the Compression Screw prior to fully seating the nail.

To reattach the Target Device to the nail, detach the Teardrop Handle from the Compression Screwdriver Shaft and screw the Nail Holding Screw over the Compression Screwdriver Shaft into its required position.

To insert the second transverse Fully Threaded Locking Screw, follow the locking procedure for static locking (Fig. 39).

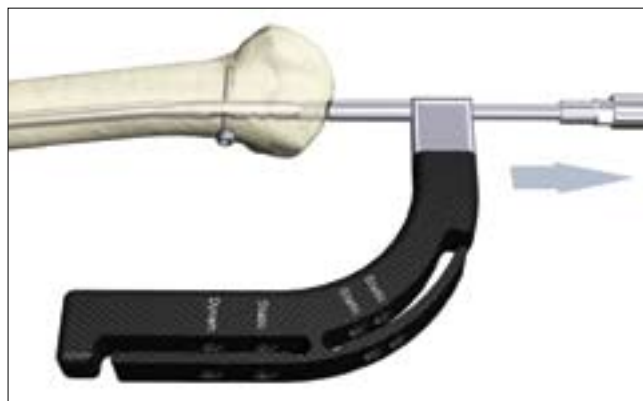

Fig.37



Fig.38



Fig.39

Antegrade Technique

5.15. Nail Removal

Nail removal is an elective procedure. If used, first remove the End Cap with the Short Screwdriver Shaft and the Teardrop Handle (Fig. 40). If Advanced Locking Mode was utilized, the most proximal screw is extracted first, allowing access to the compression screw. Next, disengage the Advanced Compression Screw from the Fully Threaded Locking Screw (Shaft Screw) by turning the Compression Screwdriver one full turn in a counter-clockwise direction (Fig. 41).

Note:
There is no need to attempt to remove the Advanced Compression Screw from the nail, which with the nail implanted, may be difficult.

The Universal Rod, Short is inserted into the driving end of the nail before all Locking Screws are removed with the Short Screwdriver Shaft and the Teardrop Handle (Fig. 41).

Note:
Attaching of the Universal Rod, to the nail first, will reduce the potential for nail migration, then the locking screws may be removed safely.

The Slotted Hammer or “optional” Sliding Hammer (1806-0175) is used to extract the nail in a controlled manner (Fig. 42).

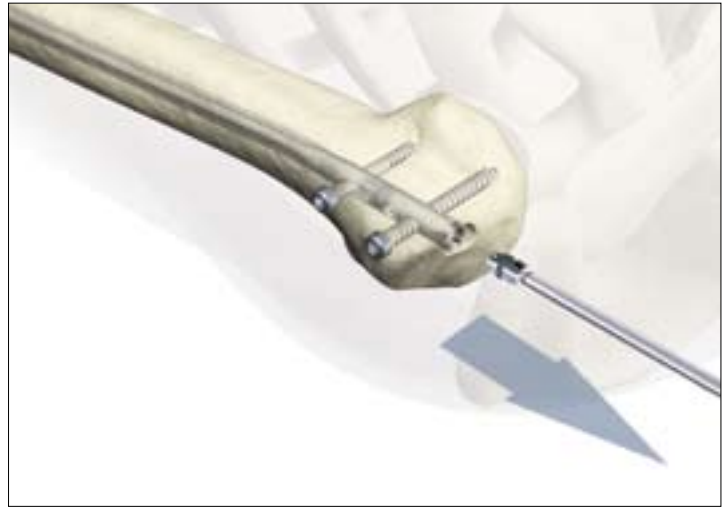

Fig. 40



Fig. 41

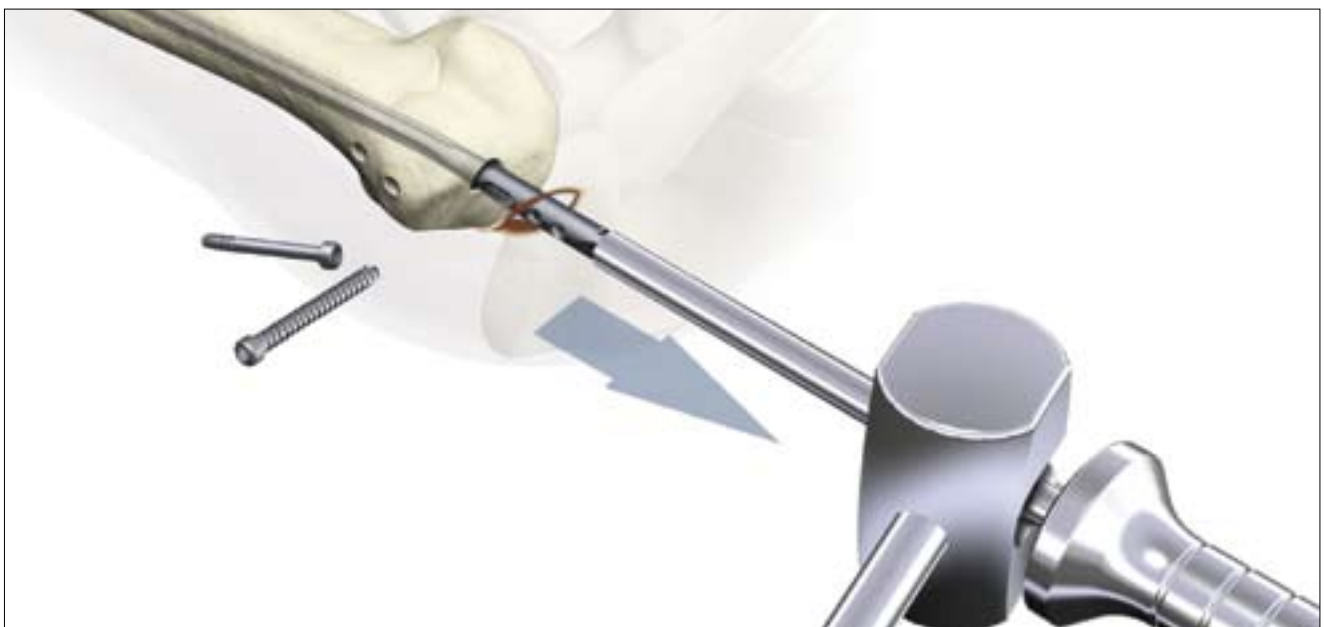

Fig. 42

Retrograde Technique

6. Retrograde Approach

6.1. Patient Positioning

The patient is placed on a radiolucent table in the prone position or lateral decubitus position. The affected arm is supported on an arm board or hand table. The shoulder is in 90° abduction, the elbow joint flexed also in a 90° position. In this position, fractures can be reduced in correct rotation.

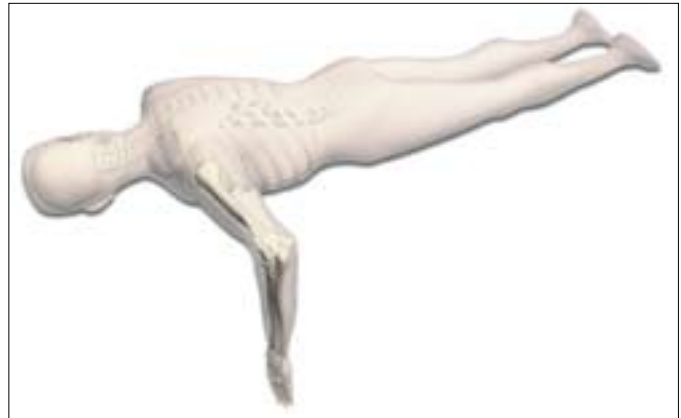

Patient positioning should be checked to ensure that imaging of the entry site at the proximal humerus is possible. This allows the elbow to be hyperflexed to accommodate insertion of the implant parallel to the humerus.



Fig. 43

6.2. Incision

A posterior approach is used to access the distal humerus. Starting at the tip of the olecranon, a 6cm incision is made in a proximal direction. The triceps tendon is split and muscle tissue is bluntly dissected and retracted until the upper edge of the olecranon fossa is displayed.



Fig. 44

The distal insertion point for the nail is one centimeter above the olecranon fossa. The Insertion Site Template (703117) may be used to help determine the appropriate insertion site (Fig. 43). The medullary canal is opened using the Drill Ø3.5 × 130mm (1806-3550S) by drilling a set of linear holes (Fig. 44). The holes are then joined with the Self-guiding Rigid Reamer (703125) (Fig. 45).

Note:

The drill guide slots of the retrograde Insertion Site Template (703117), must be centered and parallel to the medullary canal (long axis of the humerus).



Fig. 45

Retrograde Technique

6.3. Entry Point

Final insertion site preparation is performed with the Conical Rigid Reamer (703126) to create a longitudinal oval cortical hole at least 3cm in length and 1cm in width (Fig. 46).

The cortical bone is removed distally to the level of the olecranon fossa with the rigid reamers or small rongeur.

Note:

Although the tip of the nail has a 4 degree bend that facilitates distal nail insertion, high compressive forces during nail insertion can result in fractures of the distal humerus if the insertion opening is too short or too steep.

6.4. Unreamed Technique

The T2™ Humeral Nail is cannulated, and may be introduced in an unreamed fashion over a Smooth Tip Guide Wire. This simplifies fracture reduction and reduces the risk of iatrogenic distal fractures caused by trying to reduce the fracture with the nail.

The 2.2×800mm Smooth Tip Guide Wire (1806-0093S) is inserted under image control through the distal fragment and into the desired position within the proximal humerus using the Guide Wire Handle and Chuck (1806-0095 and 1806-0096) (Fig. 47 and Fig. 48).

The Reduction Rod (1806-0363), or the Universal Rod, Short (1806-0113) with the “optional” Reduction Spoon (1806-0125), may be used as a fracture reduction tool to facilitate Guide Wire insertion (Fig. 49). The Guide Wire is advanced until the tip rests at the center of the humeral head. The Guide Wire should lie in the center of the metaphysis in both the A/P and Lateral views to help avoid offset positioning of the nail. The Guide Wire Handle is removed leaving the Guide Wire in place.



Fig. 47



Fig. 46



Fig. 48



Fig. 49

Retrograde Technique

6.5. Reamed Technique

For reamed techniques, the 2.5×800mm Ball Tip Guide Wire (1806-0083S) is inserted through the fracture site. The Reduction Rod or the Universal Rod, Short with the “optional” Reduction Spoon may be used as a fracture reduction tool to facilitate Guide Wire insertion across the fracture site (see Fig. 49).

Reaming is commenced in 0.5mm increments until cortical contact is appreciated. (Fig. 50). The final reamer should be 1mm–1.5mm larger than the diameter of the nail to be used.

Note:
The driving end of the 7mm nail is always 8mm.

When reaming is complete, the Teflon Tube (1806-0073S) should be used to exchange the Ball Tip Guide Wire with the Smooth Tip Guide Wire for nail insertion.

Note:
Do not insert any T2™ Humeral Nail over any Ball Tip Guide Wire.

6.6. Nail Selection

The X-Ray Template (1806-003) should be used preoperatively to determine canal size radiographically. This information may be utilized in conjunction with the clinical assessment of canal size as determined by the size of the last reamer used.

Diameter

The diameter of the selected nail should be 1mm smaller than the last reamer used.

Length

Nail length may be determined with the X-Ray Ruler (1806-0013) (Fig. 51). The Guide Wire Ruler (1806-0020) may be used by placing it on the Guide Wire and then reading the correct nail length at the end of the Guide Wire on the Guide Wire Ruler (Fig. 52). Confirm the position of the tip of the Guide Wire prior to measurement.



Fig. 50



Fig. 51



Fig. 52

Note:
If the fracture is suitable for apposition/compression, the implant selected should be 6–10mm shorter than measured to help avoid migration of the nail beyond the insertion site.

6.7. Nail Insertion

The selected nail is assembled onto the Target Device (1806-0143) with the Nail Holding Screw (1806-0163). Tighten the Nail Holding Screw with the Insertion Wrench (1806-0135) securely so that it does not loosen during nail insertion (Fig. 53).



Fig. 53

Retrograde Technique

Note:

Prior to nail insertion please check correct alignment by inserting a drill bit through the assembled Tissue Protection- and Drill Sleeve placed in the required holes of the targeting device.

Upon completion of reaming and Guide Wire exchange, the appropriate size nail is ready for insertion and is advanced through the entry point past the fracture site to the appropriate level.

Gentle rotation of the nail may be necessary to start nail insertion. The nail should be advanced with manual pressure (Fig. 54). Aggressive use of the slotted hammer can result in additional fractures. If the nail does not advance easily, a check with image intensification should be made to see if the nail angle is too steep and the nail is impinging on the anterior cortex. In this case, it may be necessary to further widen the insertion opening.

Note:

A chamfer is located on the driving end of the nail to denote the end under X-Ray. Three circumferential grooves are located on the insertion post at 2mm, 6mm, and 10mm from the driving end of the nail (Fig. 55). Depth of insertion may be visualized with the aid of fluoroscopy.

The 3 × 285mm K-Wire may be inserted through the Target Device which identifies the junction of the nail and insertion post.

Insertion of the nail into the fracture zone should be monitored under image intensification.

The nail can be inserted over the Smooth Tip Guide Wire by gentle impaction on the Nail Holding Screw/ Insertion Wrench assembly (Fig. 56) or the Nail Holding Screw/Strike Plate assembly (Fig. 57).

Repositioning may be carried out either by hand or by attaching the Universal Rod, Short to the Nail Hold-ing Screw. The slotted hammer may be used to reposition the nail smoothly (Fig. 58). DO NOT hit on the Target Device.



Fig. 54



Fig. 55



Fig. 56



Fig. 57



Fig. 58

When locking the retrograde nail in the Static Mode, the nail is countersunk a minimum of 6mm below the surface. When the implant is inserted in the Dynamic Mode, with active apposition/compression, or in the Advanced Locking Mode, the recommended insertion depth is 10mm.

Note:

Remove the Guide Wire prior to drilling and inserting the Locking Screws.

Retrograde Technique

6.8. Guided Locking Mode (via Target Device)

Prior to guided locking via the Target Device, the Nail Holding Screw must be firmly tightened using the Insertion Wrench, to ensure that the nail is in correct alignment with the Target Device.

The Target Device is designed to provide four options for guided locking (Fig. 59.1–59.4).

In Static Oblique Locking Mode, the two static holes closest to the end of the nail may be used for static oblique (30°) locking (Fig. 59.1).

- 1. Static**
- 2. Static**

In Static Transverse Locking Mode, the next static hole and the dynamic hole are used for static transverse locking (Fig. 59.2).

- 3. Static**
- 4. Dynamic**

In controlled Dynamic Mode, and/or controlled Apposition/Compression Mode, the dynamic hole is required (Fig. 59.3).

- 4. Dynamic**

In Advanced Locking Mode, the dynamic hole is required. After utilizing compression with the Advanced Compression Screw, the static hole is used (Fig. 59.4).

- 4. Dynamic**
- 3. Static**

The Tissue Protection Sleeve, Short (1806-0180) together with the Drill Sleeve, Short (1806-0210) and the Trocar, Short (1806-0310) are inserted into the Target Device by pressing the safety clip (Fig. 60). The friction lock mechanism is designed to keep the sleeve in place and prevent it from falling out. It is designed to also keep the sleeve from sliding during screw measurement. To release the Tissue Protection Sleeve, the safety clip must be pressed again (Fig. 61).



Fig. 59.1



Fig. 59.2



Fig. 59.3



Fig. 59.4

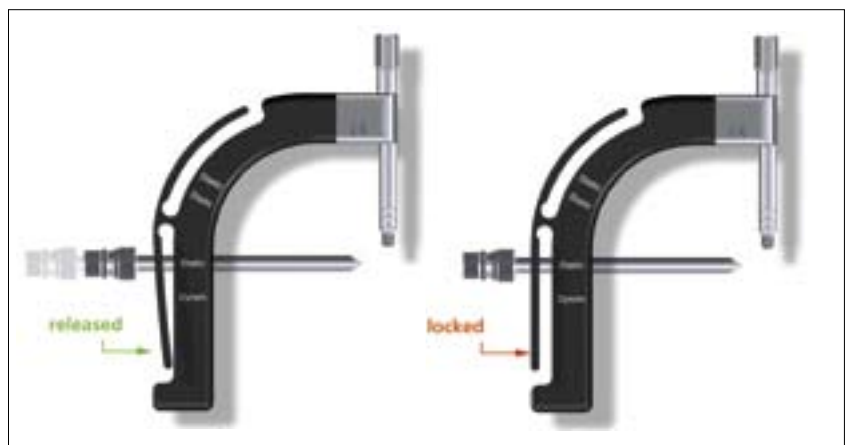

Fig. 60 & 61

Retrograde Technique

6.9. Static Locking Mode

6.9.1. Static Transverse Locking Mode

In unstable or comminuted fractures, the nail should be used as a standard interlocking nail. Static locking will help maintain the length of the nail and the rotational stability of the fracture.

The Short Tissue Protection Sleeve together with the Short Drill Sleeve and the Short Trocar are positioned through the static locking hole on the Target Device. A small skin incision is made and the assembly is pushed through, until it is in contact with the posterior cortex of the humerus.

Note:

Especially in the proximal humerus, use image intensification to help ensure the Tissue Protection sleeve is flush with the cortex or you could lose 1–2mm of screw measurement accuracy.

The Trocar is removed, while the Tissue Protection Sleeve and the Drill Sleeve remain in position.

For accurate drilling and easy determination of screw length, use the center-tipped $\text{Ø}3.5 \times 230\text{mm}$ calibrated Drill (1806-3540S). The Drill is forwarded through the Drill Sleeve and pushed onto the cortex.

After drilling both cortices, the screw length may be read directly off of the calibrated Drill at the end of the Drill Sleeve (Fig. 62 and Fig. 63).

Note:

The position of the end of the Drill as it relates to the far cortex is equal to where the end of the screw will be. Therefore, if the end of the Drill is 3mm beyond the far cortex, the end of the screw will also be 3mm beyond.

Note: The Screw Gauge, Short, is calibrated so that with the bend at the end pulled back flush with the far cortex, the screw tip will end 3mm beyond the far cortex (Fig. 63)

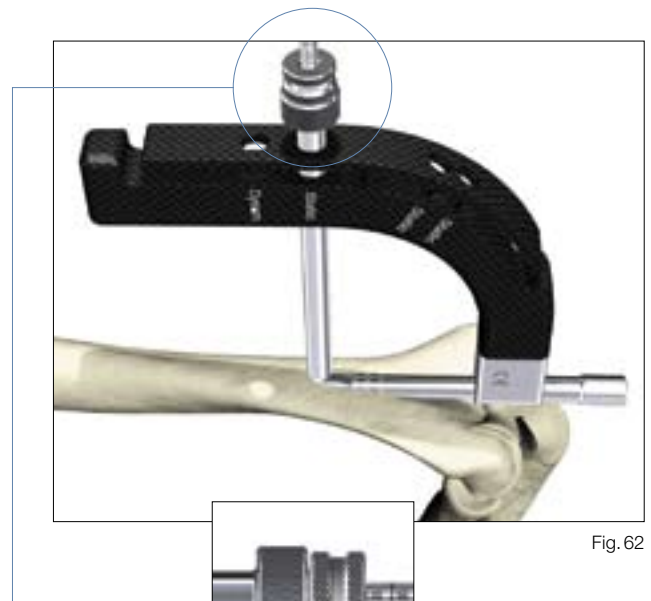

Fig. 62

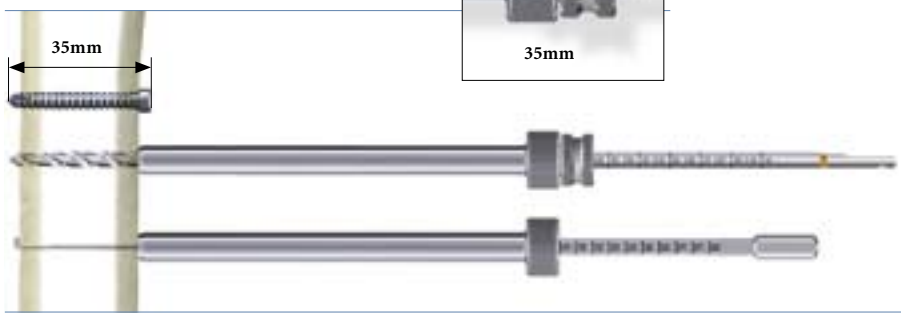

Fig. 63

When the Drill Sleeve is removed, the correct 4mm Locking Screw is inserted through the Tissue Protection Sleeve using the Short Screwdriver Shaft (1806-0222) with the Teardrop Handle (702429). The screw is driven through both cortices and is near its' proper seating position when the center of the groove around the shaft of the screwdriver is approaching the end of the Tissue Protection Sleeve (Fig. 64).

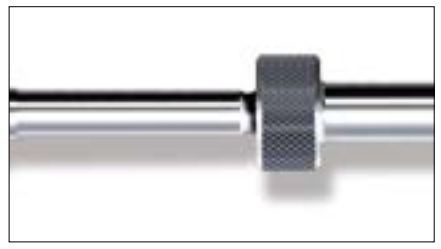

Fig. 64

Use image intensification to confirm screw position through the nail as well as screw length. Repeat the locking procedure for the other statically positioned Locking Screw (Fig. 65).

Note:

Only the Static Transverse Locking Option allows the nail to be easily compressed in a secondary procedure. The static Locking Screw closest to the driving end of the nail may be removed and the Compression Screw can be inserted into the nail.

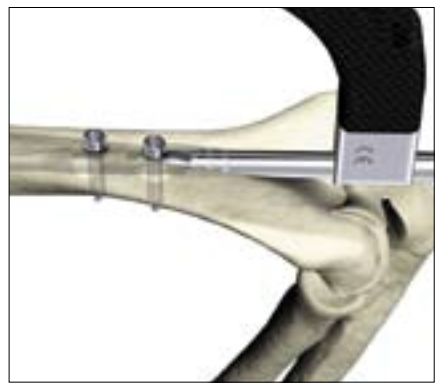

Fig. 65

Retrograde Technique

6.9.2. Static Oblique Locking Mode

For the Static Oblique Locking Mode, place the assembly of Tissue Protection Sleeve together with the Drill Sleeve and the Trocar through the Static hole closest to the driving end of the nail. Refer to the procedure described in 6.9.1. for Locking Screw insertion (Fig. 66).

The second Fully Threaded Locking Screw is inserted through the Static hole next to the first hole and placed in an oblique manner through the oblong hole of the nail (Fig. 67).

Confirm screw position and length with image intensification.

6.9.3. Washer

If the nail insertion opening is too long, or if osteoporotic bone is encountered, it may not be possible to achieve bicortical purchase for the most distal Fully Threaded Locking Screw. A Washer, either Rectangular or Round, may be used to bridge the bone gap and allow for enhanced purchase of the Locking Screw (Fig. 68).



Fig. 66



Fig. 67



Fig. 68

Retrograde Technique

6.10. Freehand Proximal Locking

The freehand technique is used to insert Locking Screws into both the A/P and M/L holes in the nail. Rotational alignment must be checked prior to locking the nail statically.

Multiple locking techniques and radiolucent drill devices are available for freehand locking. The critical step with any freehand locking technique, proximal or distal, is to visualize a perfectly round locking hole with the C-Arm.

The center-tipped $\text{Ø}3.5 \times 230\text{mm}$ Drill (1806-3540S), or the optional $\text{Ø}3.5 \times 130\text{mm}$ Drill (1806-3550S), is held at an oblique angle to the center of the locking hole (Fig. 69). Upon X-Ray verification, the Drill is placed perpendicular to the nail and drilled through the anterior cortex. Confirm these views in both the A/P and M/L planes by X-Ray.

After drilling both cortices, the screw length may be read directly off of the Screw Scale, Short (1806-0360) at the orange color coded ring on the center-tipped Drill (Fig. 70). As with distal locking (Fig. 63, p. 27), the position of the end of the drill is equal to the end of the screw as they relate to the far cortex.

Routine Locking Screw insertion is employed with the assembled Short Screwdriver Shaft and the Teardrop Handle.

If possible, the proximal humerus should be locked with two Fully Threaded Locking Screws (Fig. 71).

Note:
Use image intensification to confirm screw position within the nail as well as screw length.

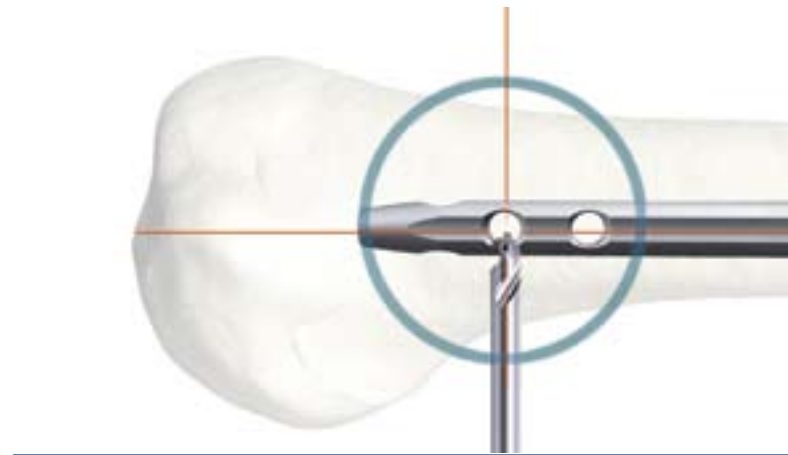

Fig. 69

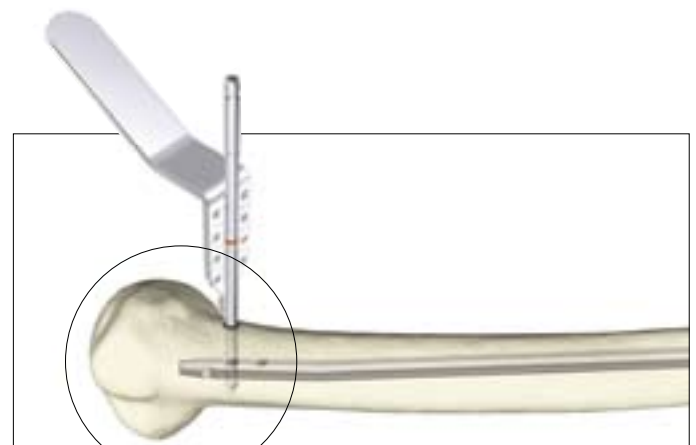

Fig. 70



Fig. 71

Retrograde Technique

6.11. End Cap Insertion

After removal of the Target Device, an End Cap is used to reduce the potential for bony ingrowth into the proximal threads of the nail.

End Caps are available in six sizes (Fig. 72).

The End Cap is inserted with the Short Screwdriver Shaft assembled on the Teardrop Handle after intra-operative radiographs show satisfactory reduction and hardware implantation (Fig. 73). Fully seat the End Cap to minimize the potential for loosening.

Note:
To avoid impingement, carefully select the length of the End Cap.

Close the wound using standard technique.



Fig. 72



Fig. 73

6.12. Dynamic Locking Mode

Controlled dynamic locking may be utilized for transverse or axially stable fractures.

Retrograde dynamization is performed by statically locking the nail proximally.

The guided Locking Screw is then placed in the dynamic position of the oblong hole. This allows the nail to move, and the fracture to settle while torsional stability is maintained (Fig. 74).



Fig. 74

Retrograde Technique

6.13. Apposition/Compression Locking Mode

In transverse or axially stable fracture patterns, active apposition/compression increases fracture stability and enhances fracture healing. The retrograde T2™ Humeral Nail provides the option to treat a humerus fracture with active mechanical apposition/compression prior to leaving the operating room.

Note:

Proximal freehand static locking must be performed prior to applying active, controlled apposition/compression to the fracture site.

If active apposition/compression is required, a Partially Threaded Locking Screw (Shaft Screw) is inserted via the Target Device in the dynamic position of the oblong hole. This will allow for a maximum of 6mm of active, controlled apposition/compression. In order to insert the Partially Threaded Locking Screw (Shaft Screw), drill both cortices with the Ø3.5×230mm Drill (1806-3540S). Next, **the near cortex ONLY is overdrilled** with the Ø4.0×180mm Drill (1806-4000S).

Note:

After the opposite cortex is drilled with the Ø3.5×230mm Drill, the correct screw length can be read directly off of the calibrated Drill at the end of the Drill Sleeve.

Note:

It may be easier to “insert” the Compression Screw prior to fully seating the nail. Once the nail tip has cleared the fracture site, the Guide Wire (if used) is withdrawn. With the proximal portion of the nail not fully seated and extending out of the bone, the Advanced Compression Screw is inserted. Care should be taken that the shaft of the Compression Screw does not extend into the area of the oblong hole.

After the Partially Threaded Locking Screw (Shaft Screw) is inserted, the Nail Holding Screw is removed, leaving the insertion post intact with the nail (Fig. 75). This will act as a guide for the Compression Screw.



Fig. 75



Fig. 76



Fig. 77

The Compression Screw is inserted with the Compression Screwdriver Shaft (1806-0263) assembled on the Teardrop Handle through the insertion post (Fig. 76).

The Short Tissue Protection Sleeve is removed and the Compression Screw is gently tightened utilizing the two-finger technique. As the Compression Screw is advanced against the 4.0mm Partially Threaded Locking Screw (Shaft Screw), it draws the proximal fracture segment towards the fracture site, employing active apposition/compression (Fig. 77). Image intensification will enable the surgeon to visualize active apposition/compression. Some bending of the

transverse Partially Threaded Locking Screw (Shaft Screw) may be seen.

Note:

Apposition/compression must be carried out under X-Ray control. Over compression may cause the nail or the Partially Threaded Locking Screw (Shaft Screw) to fail.

Note: When compressing the nail, the implant must be inserted a safe distance from the entry point to accommodate for the 6mm of active compression. The three grooves on the insertion post are designed to help attain accurate insertion depth of the implant.

Retrograde Technique

6.14. Advanced Locking Mode

In order to achieve additional fixation and to reduce the load on the Partially Threaded Locking Screw (Shaft Screw), the design of the T2™ Humeral Nail provides the opportunity to insert an additional Fully Threaded Locking Screw in the other transverse hole at the driving end of the nail after apposition/compression is utilized.

Prior to guided locking via the Target Device, the Nail Holding Screw must be tightened using the Insertion Wrench.

The Compression Screw is inserted with the Compression Screwdriver Shaft. Fix the Compression Screw on the self-retaining Compression Screwdriver Shaft. Remove the Nail Holding Screw leaving the Target Device in place (Fig. 78). Advance the Compression Screw through the Target Device until the desired amount of compression is achieved. Visualize depth of insertion with the aid of fluoroscopy (Fig. 79).

Note:

As previously described, it may be easier to insert the Compression Screw prior to fully seating the nail.

To reattach the Target Device to the nail, detach the Compression Screw Driver and screw the Nail Holding Screw into its required position. To reattach the Target Device to the nail, detach the Teardrop Handle from the Compression Screwdriver Shaft and screw the Nail Holding Screw over the Compression Screwdriver Shaft into its required position.

To insert the second transverse Fully Threaded Locking Screw, follow the locking procedure for static locking (Fig. 80 and Fig. 81).

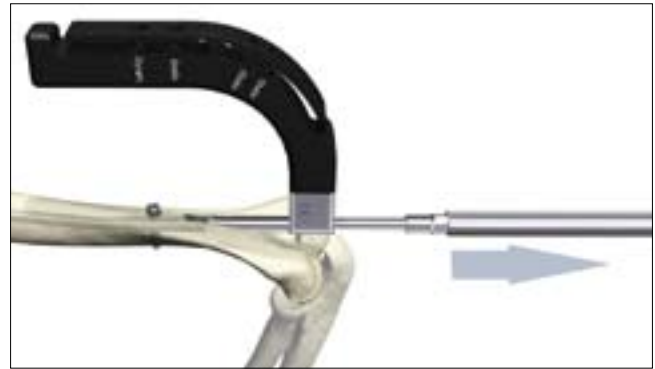

Fig. 78



Fig. 79



Fig. 80



Fig. 81

Retrograde Technique

6.15. Nail Removal

Nail removal is an elective procedure. If they were used, the End Cap and Compression Screw are removed with the Short Screwdriver Shaft and the Teardrop Handle. If Advanced Locking Mode was utilized, the most distal screw is extracted first, thus allowing access to the compression screw.

The Universal Rod, Short is inserted into the driving end of the nail before all Locking Screws are removed with the Short Screwdriver Shaft and the Teardrop Handle (Fig. 82).

Note:

Attaching the Universal Rod to the nail first, will reduce the potential for nail migration, then the Locking Screws may be removed safely.

The Slotted Hammer or “optional” Sliding Hammer (1806-0175) is used to extract the nail in a controlled manner (Fig. 83).



Fig. 82

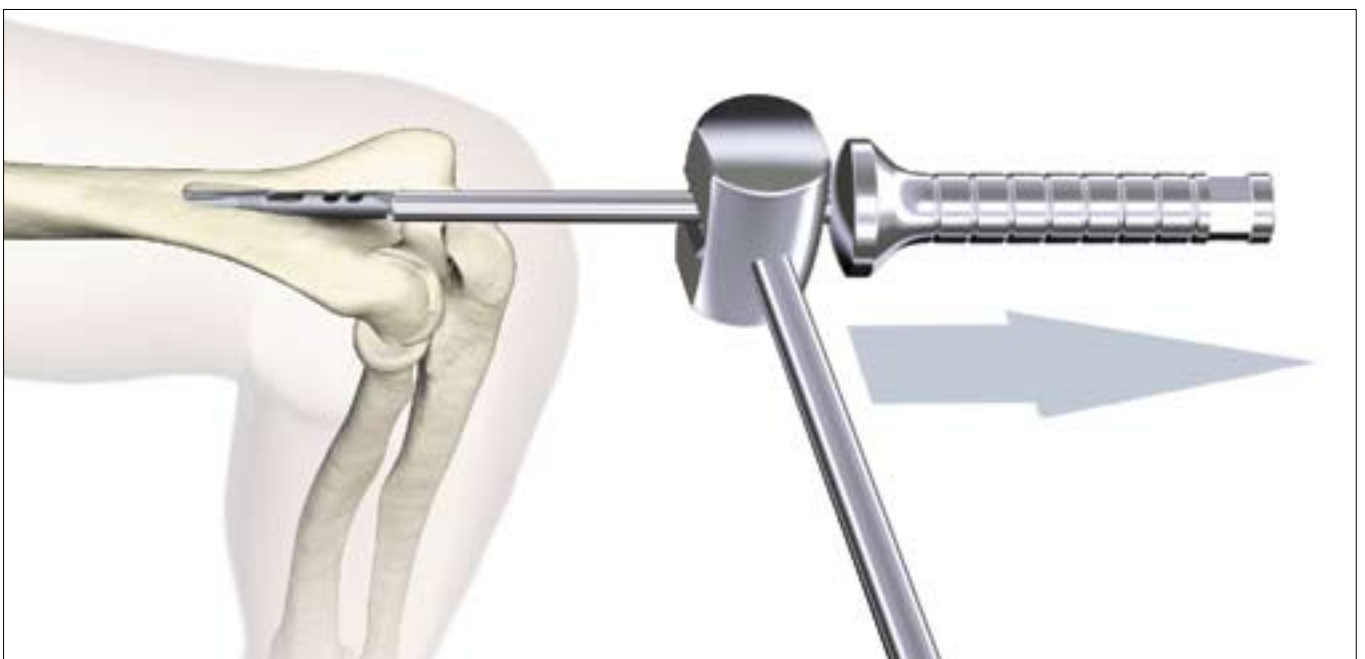

Fig. 83

Ordering Information - Implants

T2™ Humeral Locking Nail



REF	Diameter mm	Length mm
1830-0714S	7.0	140
1830-0716S	7.0	160
1830-0718S	7.0	180
1830-0719S	7.0	190
1830-0720S	7.0	200
1830-0721S	7.0	210
1830-0722S	7.0	220
1830-0723S	7.0	230
1830-0724S	7.0	240
1830-0725S	7.0	250
1830-0726S	7.0	260
1830-0727S	7.0	270
1830-0728S	7.0	280
1830-0729S	7.0	290
1830-0730S	7.0	300
1830-0731S	7.0	310
1830-0732S	7.0	320
1830-0814S	8.0	140
1830-0816S	8.0	160
1830-0818S	8.0	180
1830-0819S	8.0	190
1830-0820S	8.0	200
1830-0821S	8.0	210
1830-0822S	8.0	220
1830-0823S	8.0	230
1830-0824S	8.0	240
1830-0825S	8.0	250
1830-0826S	8.0	260
1830-0827S	8.0	270
1830-0828S	8.0	280
1830-0829S	8.0	290
1830-0830S	8.0	300
1830-0831S	8.0	310
1830-0832S	8.0	320
1830-0914S	9.0	140
1830-0916S	9.0	160
1830-0918S	9.0	180
1830-0919S	9.0	190
1830-0920S	9.0	200
1830-0921S	9.0	210
1830-0922S	9.0	220
1830-0923S	9.0	230
1830-0924S	9.0	240
1830-0925S	9.0	250
1830-0926S	9.0	260
1830-0927S	9.0	270
1830-0928S	9.0	280
1830-0929S	9.0	290
1830-0930S	9.0	300
1830-0931S	9.0	310
1830-0932S	9.0	320

Ordering Information - Implants

4mm Fully Threaded Locking Screws+



REF	Diameter mm	Length mm
1896-4020S	4.0	20
1896-4022S	4.0	22
1896-4024S	4.0	24
1896-4025S	4.0	25
1896-4026S	4.0	26
1896-4028S	4.0	28
1896-4030S	4.0	30
1896-4032S	4.0	32
1896-4034S	4.0	34
1896-4035S	4.0	35
1896-4036S	4.0	36
1896-4038S	4.0	38
1896-4040S	4.0	40
1896-4045S	4.0	45
1896-4050S	4.0	50
1896-4055S	4.0	55
1896-4060S	4.0	60

End Caps



REF	Diameter mm	Length mm
1830-0003S	6.0	±0
1830-0005S	6.0	+5
1830-0010S	6.0	+10
1830-0015S	6.0	+15
1830-0020S	6.0	+20
1830-0025S	6.0	+25

4mm Partially Threaded Locking Screws+



(Shaft Screws)

REF	Diameter mm	Length mm
1891-4020S	4.0	20
1891-4022S	4.0	22
1891-4024S	4.0	24
1891-4025S	4.0	25
1891-4026S	4.0	26
1891-4028S	4.0	28
1891-4030S	4.0	30
1891-4032S	4.0	32
1891-4034S	4.0	34
1891-4035S	4.0	35
1891-4036S	4.0	36
1891-4038S	4.0	38
1891-4040S	4.0	40
1891-4045S	4.0	45
1891-4050S	4.0	50
1891-4055S	4.0	55
1891-4060S	4.0	60

Washers



REF	Description
1830-0008S	Washer, round
1830-0009S	Washer, square

Advanced Compression Screw, Humerus













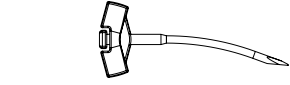

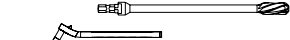

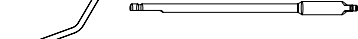
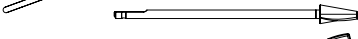

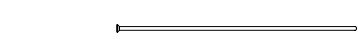



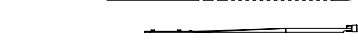



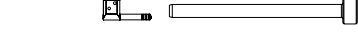
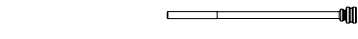

REF	Diameter mm
1830-0001S	6.0

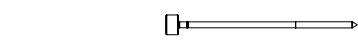
Implants in sterile packaging.

















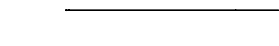
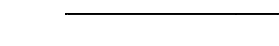
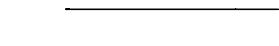





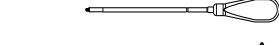









Note:
Check with local representative regarding availability of sizes.

+ Outside of the U.S., Locking Screws may be ordered non-sterile without the "S" at the end of the corresponding Catalogue Number.

Ordering Information - Instruments

	REF	Description
		Standard Instruments
	1806-6003	T2™ Humeral Instrument Set, Basic
	1806-0040	Awl, Curved, Ø10mm
	1806-0050	K-Wire, Ø3×285mm
	1806-2010	Rigid Reamer, Ø10mm
	703117	Insertion Site Template
	703125	Self Guiding Rigid Reamer
	703126	Conical Rigid Reamer
	1806-0095	Guide Wire Handle
	1806-0096	Guide Wire Handle Chuck
	1806-0073	Teflon Tube
	1806-0113	Universal Rod, Short
	1806-0363	Reduction Rod, Ø7mm
	1806-0013	X-Ray Ruler, Humerus
	1806-0020	Guide Wire Ruler
	1806-0135	Insertion Wrench, Ø10mm
	1806-0150	Strike Plate
	1806-0163	Nail Holding Screw, Humerus
	1806-0170	Slotted Hammer
	1806-0143	Target Device, Humerus
	1806-0180	Tissue Protection Sleeve, Short
	1806-0210	Drill Sleeve, Short
	1806-0263	Screwdriver Shaft, Compression
	1806-0310	Trocar, Short
	1806-0330	Screw Gauge, Short
	1806-3540	Drill Ø3.5×230mm, AO
	1806-4000	Drill Ø4×180mm, AO
	1806-0222	Screwdriver Shaft AO, Short
	702429	Teardrop Handle, AO Coupling
	1806-0292	Screwdriver Shaft, 3.5×85mm
	1806-0360	Screw Scale, Short
	1806-9003	Humerus Instrument Tray

Ordering Information - Instruments

REF	Description
Optional Instruments	
	1806-0003 X-Ray Template, Humerus
	1806-0032 Awl Plug
	1806-0043 Awl, Curved Ø8mm
	1806-0045 Awl, Ø10mm Straight
	1806-0050S K-Wire, 3 x 285mm, sterile (U.S.)
	1806-0073S Teflon Tube, Sterile (U.S.)
	1806-0083 Guide Wire, Ball Tip, Ø2.5 x 800mm
	1806-0093 Guide Wire, Smooth Tip, Ø2.2 x 800mm
	1806-0083S Guide Wire, Ball Tip, Ø2.5 x 800mm, Sterile (U.S.)
	1806-0093S Guide Wire, Smooth Tip, Ø2.2 x 800mm, Sterile (U.S.)
	1806-0110 Universal Rod, Long
	1806-0125 Reduction Spoon
	1806-0130 Wrench, 8mm/10mm
	1806-0175 Sliding Hammer
	1806-0237 Screwdriver, Short
	1806-0245 Screw Capture Sleeve, Short
	1806-0300 Screwdriver Shaft, Ball Tip
	1806-0353 Extraction Rod, Conical
	1806-3540S Drill Ø3.5 x 230mm, AO, sterile (U.S.)
	1806-3545 Drill Ø3.5 x 230mm, Tri-Flat, (outside of U.S.)
	1806-3545S Drill Ø3.5 x 230mm, Tri-Flat, sterile (outside of U.S.)
	1806-3550 Drill Ø3.5 x 130mm, AO, (outside of U.S.)
	1806-3555 Drill Ø3.5 x 130mm, Tri-Flat, (outside of U.S.)
	1806-3550S Drill Ø3.5 x 130mm, AO, sterile (U.S.)
	1806-3555S Drill Ø3.5 x 130mm, Tri-Flat, Sterile (outside of U.S.)
	1806-4000S Drill Ø 4 x 180mm, AO, Sterile (U.S.)
	1806-4005 Drill Ø4 x 180mm, Tri-Flat, (outside of U.S.)
	1806-4005S Drill Ø4 x 180mm, Tri-Flat, (outside of U.S.)
	1806-9013 Humerus Screw Tray
REF	Description
Special Order Items	
	1806-0120 Reduction Tip
	1806-0202 Screwdriver, Extra Short
	1806-0340 Extraction Adapter
	1806-0390 Depth Gauge, Standard Style for Freehand Locking
	702427 T-Handle, AO Coupling
	703166 Freehand Drill Sleeve

* Instruments designated "Outside of the U.S." may not be ordered for the U.S. market.

Ordering Information - Instruments

Bixcut™

Complete range of modular and fixed-head reamers to match surgeon preference and optimize O. R. efficiency, presented in fully sterilizable cases.

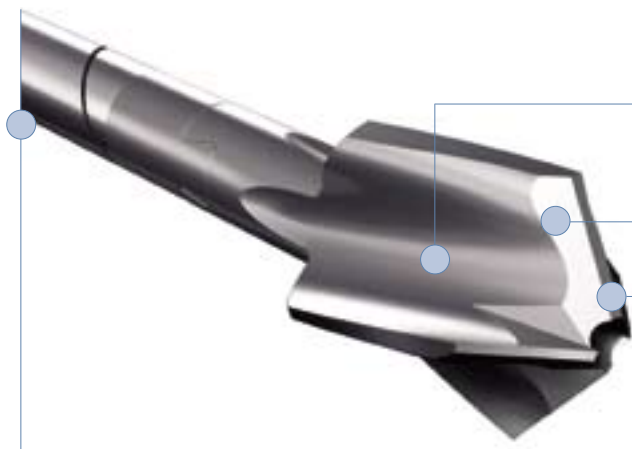

Large clearance rate resulting from reduced number of reamer blades coupled with reduced length of reamer head to give effective relief of pressure and efficient removal of material.

Cutting flute geometry optimized to lower pressure generation.

Forward- and side-cutting face combination produces efficient material removal and rapid clearance.

Double-wound shaft transmits torque effectively and with high reliability. Low-friction surface finish aids rapid debris clearance.

Smaller, 6 and 8mm shaft diameters significantly reduce IM pressure.

Typical Standard
Reamer Ø14mm

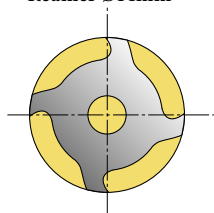

Clearance area:
32% of cross section

Bixcut™
Reamer Ø14mm

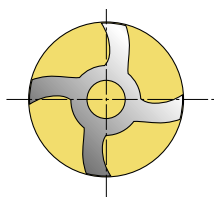

Clearance area:
59% of cross section

Recent studies¹ have demonstrated that the pressures developed within the medullary cavity through the introduction of unreamed IMnails can be far greater than those developed during reaming – but this depends very much upon the design of the reamer.

After a three year development study² involving several universities, the factors that determine the pressures and temperatures developed during reaming were clearly established. These factors were applied to the development of advanced reamers that demonstrate significantly better performance than the best of previous designs.

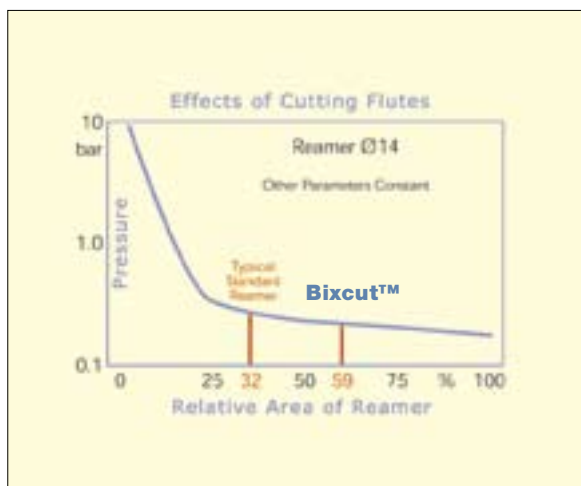

¹ Jan Paul M. Frolke, et al.; Intramedullary Pressure in Reamed Femoral Nailing with Two Different Reamer Designs., Eur. J. of Trauma, 2001 #5

² Medhi Massau, et al.; Pressure Changes During Reaming with Different Parameters and Reamer Designs, Clinical Orthopaedics and Related Research Number 373, pp. 295-303, 2000

Ordering Information - Instruments

Bixcut™ Modular Head

REF	Description	Diameter mm
0226-3090	Bixcut Head	9.0
0226-3095	Bixcut Head	9.5
0226-3100	Bixcut Head	10.0
0226-3105	Bixcut Head	10.5
0226-3110	Bixcut Head	11.0
0226-3115	Bixcut Head	11.5
0226-3120	Bixcut Head	12.0
0226-3125	Bixcut Head	12.5
0226-3130	Bixcut Head	13.0
0226-3135	Bixcut Head	13.5
0226-3140	Bixcut Head	14.0
0226-3145	Bixcut Head	14.5
0226-3150	Bixcut Head	15.0
0226-3155	Bixcut Head	15.5
0226-3160	Bixcut Head	16.0
0226-3165	Bixcut Head	16.5
0226-3170	Bixcut Head	17.0
0226-3175	Bixcut Head	17.5
0226-3180	Bixcut Head	18.0
0226-4185	Bixcut Head	18.5
0226-4190	Bixcut Head	19.0
0226-4195	Bixcut Head	19.5
0226-4200	Bixcut Head	20.0
0226-4205	Bixcut Head	20.5
0226-4210	Bixcut Head	21.0
0226-4215	Bixcut Head	21.5
0226-4220	Bixcut Head	22.0
0226-4225	Bixcut Head	22.5
0226-4230	Bixcut Head	23.0
0226-4235	Bixcut Head	23.5
0226-4240	Bixcut Head	24.0
0226-4245	Bixcut Head	24.5
0226-4250	Bixcut Head	25.0
0226-4255	Bixcut Head	25.5
0226-4260	Bixcut Head	26.0
0226-4265	Bixcut Head	26.5
0226-4270	Bixcut Head	27.0
0226-4275	Bixcut Head	27.5
0226-4280	Bixcut Head	28.0

Bixcut™ Shaft – AO fitting

REF	Description	Length mm
0226-3000	Shaft, AO	450
0226-8240	Shaft, AO	240

Bixcut™ Shaft – Modified Trinkle fitting (sterile)+

REF	Description	Length mm
0227-3000(S)	Shaft, Mod. Trinkle	450
0227-8240(S)	Shaft, Mod. Trinkle	240

Bixcut™ Trays

REF	Description
0225-6000	Tray, Modular Head (up to size 22.0mm)
0225-6001	Tray, Modular Head (up to size 28.0mm)
0225-8000	Tray, Fixed Head (up to size 18.0mm)

Bixcut™ Fixed Head – AO fitting

REF	Diameter mm	Length mm
0225-5060	6.0*	400
0225-5065	6.5*	400
0225-5070	7.0*	400
0225-6075	7.5	480
0225-6080	8.0	480
0225-6085	8.5	480
0225-6090	9.0	480
0225-6095	9.5	480
0225-6100	10.0	480
0225-6105	10.5	480
0225-6110	11.0	480
0225-8115	11.5	480
0225-8120	12.0	480
0225-8125	12.5	480
0225-8130	13.0	480
0225-8135	13.5	480
0225-8140	14.0	480
0225-8145	14.5	480
0225-8150	15.0	480
0225-8155	15.5	480
0225-8160	16.0	480
0225-8165	16.5	480
0225-8170	17.0	480
0225-8175	17.5	480
0225-8180	18.0	480

Bixcut™ Fixed Head – Modified Trinkle fitting+

REF	Diameter mm	Length mm
0227-5060	6.0*	400
0227-5065	6.5*	400
0227-5070	7.0*	400
0227-6075	7.5	480
0227-6080	8.0	480
0227-6085	8.5	480
0227-6090	9.0	480
0227-6095	9.5	480
0227-6100	10.0	480
0227-6105	10.5	480
0227-6110	11.0	480
0227-8115	11.5	480
0227-8120	12.0	480
0227-8125	12.5	480
0227-8130	13.0	480
0227-8135	13.5	480
0227-8140	14.0	480
0227-8145	14.5	480
0227-8150	15.0	480
0227-8155	15.5	480
0227-8160	16.0	480
0227-8165	16.5	480
0227-8170	17.0	480
0227-8175	17.5	480
0227-8180	18.0	480

+ Use with Stryker Power Equipment

* Use with 2.2mm × 800mm Smooth Tip and 2.5mm × 800mm Ball Tip Guide wires only.

