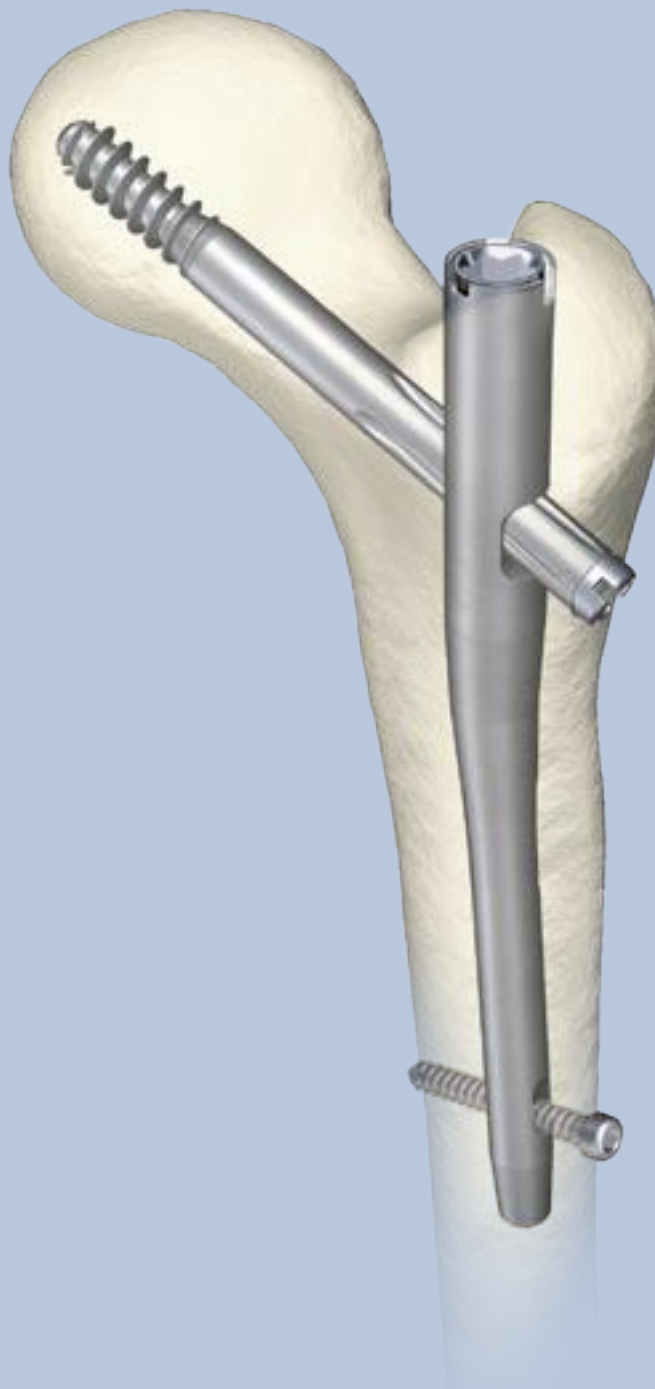


Gamma3™

Trochanteric Nail 180

Operative Technique

Hip Fracture Systems



Trochanteric Nail 180

Contributing Surgeons:

Prof. Kwok Sui Leung, M.D.

Chairman of Department of Orthopaedics and Traumatology
The Chinese University of Hong Kong
Prince of Wales Hospital
Hong Kong

Dr. Gilbert Taglang

Head of the Trauma Department
Center for Traumatology, Strasbourg
France

Prof. Dr. med. Volker Bühren

Chief of Surgical Services
Medical Director of Murnau Trauma Center, Murnau
Germany

Katsumi Sato M.D. Ph.D.

Vice-Director, Chief Surgeon
Tohoku University Graduate School of Medicine
Tohoku Rosai Hospital, Sendai
Japan

Christopher T. Born M.D.

Professor of Orthopaedic Surgery
Temple University
Philadelphia, PA
USA

Robert Probe, M.D.

Division of Orthopaedic Surgery
Scott & White Memorial Hospital, Temple, Tx
USA

Prof. Dr.med.Vilmos Vécsei

Chief of Traumatology Department
University of Vienna, Vienna
Austria

This publication sets forth detailed recommended procedures for using Stryker Trauma devices and instruments.

It offers guidance that you should heed, but, as with any such technical guide, each surgeon must consider the particular needs of each patient and make appropriate adjustments when and as required. A workshop training is required prior to first surgery.

Note:

All bone screws referenced in this material here are not approved for screw attachment or fixation to the posterior elements (pedicles) of the cervical, thoracic or lumbar spine.

Contents

Introduction	4
Design Features of the Gamma3™ System	5
Lag Screw and Set Screw Function	6
Distal Locking Screws	7
Gamma3 System Benefits	8
Indications/Contraindications	9
Operative Technique	
Implant Selection	10
Patient Positioning and Fracture Reduction	11
Incision	12
Entry Point	14
Preparation of Medullary Canal	14
One Step Conical Reamer	16
Cannulated Cutter	18
Assembly of Targeting Device	19
Nail Insertion	22
Lag Screw Positioning using One Shot Device	23
Lag Screw Insertion	24
Lag Screw Fixation	29
Distal Screw Locking	32
End Cap Insertion	34
Nail Extension End Caps	35
Postoperative Care and Rehabilitation	35
Extraction of the Gamma3 Implants	36
Dealing with Special Cases	38
<hr/>	
Ordering Information – Instruments	39
Ordering Information – Implants	41
Publications	44
Notes	45

Introduction

Introduction

The Gamma3™ Locking Nail System is based on more than 15 years of Gamma Nail experience. This is the third generation of intramedullary short and long Gamma fixation nails.

The Evolution of the successful Trochanteric and Long Gamma Nails as well as the Asia Pacific and Japanese versions followed strictly a step by step improvement based on the clinical experience of the clinical outcome from surgeons all over the world.

The new Gamma3 System is designed to facilitate minimally invasive surgery and reduce the OR time down to a minimum by the aid of using new instrumentation and an optimized surgical technique.

The nails have a proximal diameter of 15.5mm to help minimize the incision length required for minimally invasive surgery. Nevertheless, they offer the same biomechanical strength and cut-out resistance as the well established Trochanteric and Long Gamma Nails.

The new Lag Screw shape has been improved, especially in the area of the thread and the cutting flutes at the tip of the screw. The new design offers superior cutting behavior during Lag Screw insertion, providing extremely low insertion torque. The new thread design also offers excellent grip in the cancellous bone of the femoral head and strong resistance against cut-out.

The 5mm distal locking screws are currently used in the Gamma-Ti and the T2 intramedullary nailing systems.

A major advantage of the system is the newly designed instrument platform. The instruments are designed for a minimally invasive surgical technique and reduce OR time to a minimum. The instruments are easy to use and easy to clean, and they share the same platform as the Stryker intramedullary T2 and S2 nails.

Acknowledgements:

Our thanks are due to the many surgeons who supported the development of the new Gamma3 System, with their feedback and ideas, during worldwide panel meetings and helped the Gamma3 System to be what it is today.

Special thanks to the Asian Pacific Technical Committee, who supported very early the idea of smaller implants for the treatment of proximal femur fractures.



Features

Design Features of the Gamma3™ System

Gamma3 Locking Nails come in 3 neck-shaft angles of 120, 125 and 130°.

- In the following, the Trochanteric Nail 180 is called: Gamma3™ Nail 180

All nails* use the same Lag Screws, Set Screw, distal Locking Screws and End Caps (see Fig. 3).

Gamma3 Nail 180

The anatomical shape of the nail is universal for all indications involving the treatment of trochanteric fractures. The nail is cannulated for Guide-Wire-controlled insertion and features a conical tip for optimal alignment with inner part of the cortical bone.

A range of three different neck-shaft angles are available for Lag Screw entry to accommodate variations in femoral neck anatomy.

A single distal Locking Screw is provided to stabilize the nail in the medullary canal and to prevent rotation in complex fractures. The oblong hole allows static or dynamic locking.

Technical Specifications:

- **Material:** Titanium alloy with anodized type II surface treatment or Orthinox® High Strength Stainless Steel
- **Nail length:** 180mm
- **Nail diameter:** proximal 15.5mm, distal: 11.0mm
- **Proximal Nail angle range:** 120°, 125°, 130°
- **M-L bend for valgus curvature:** 4 degrees
- **End Caps in lengths of** 0mm, +5mm and +10mm
- **Distal oblong hole for** 5mm screws; up to 5mm dynamization is possible

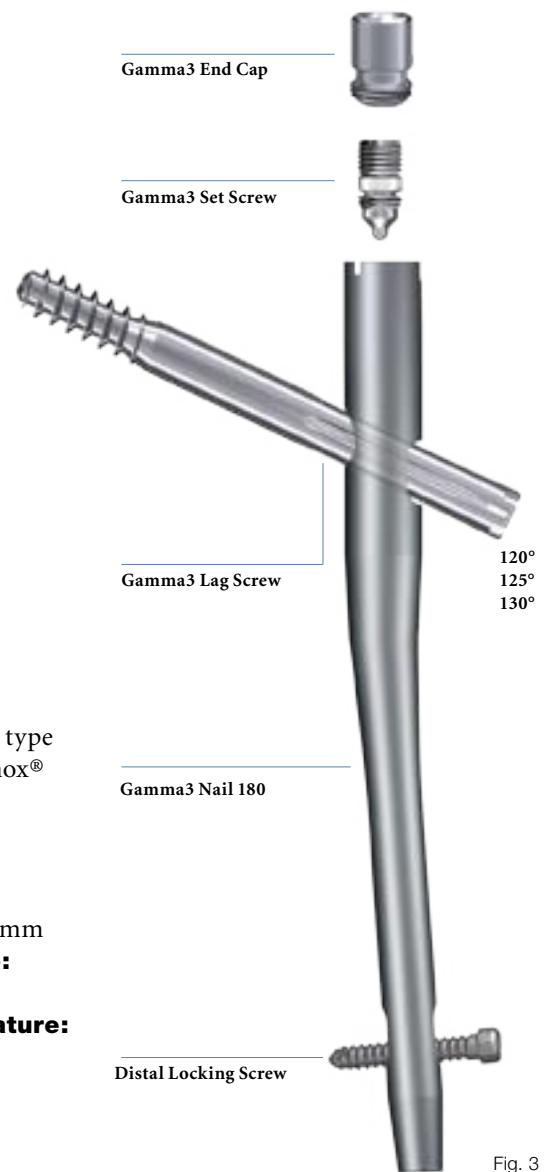


Fig. 3

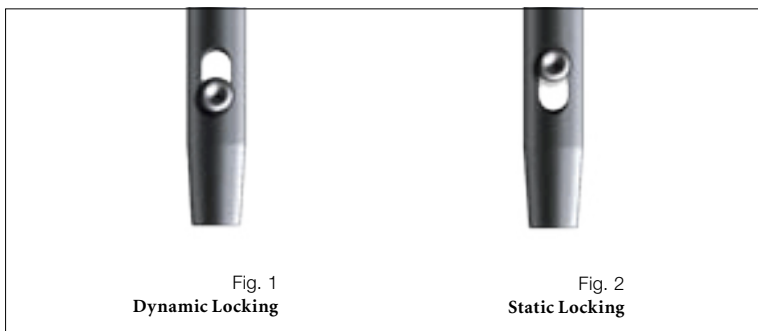


Fig. 1
Dynamic Locking

Fig. 2
Static Locking

Distal Locking Options

- Locking in the distal part of the oblong hole creates a dynamic locking mechanism (see Fig. 1).
- Locking in the proximal part of the oblong hole allows static locking of the nail (see Fig. 2).

* Each nail is supplied sterile packaged together with a Set Screw in one box.

Implant Features



Lag Screw and Set Screw Function

The Lag Screws are designed to transfer the load of the femoral head into the nail shaft by bridging the fracture line to allow fast and secure fracture healing. The load carrying thread design of the Gamma3 Lag Screw provides large surface contact to the cancellous bone. This provides high resistance against cut out. Gamma3 Lag Screws feature a special tip profile to allow use with bone substitutes and the self-tapping thread is designed for easy insertion.

The patented Set Screw is designed to fit into one of the four grooves of the shaft of the Lag Screw. This prevents both, rotation and medial migration of the Lag Screw.

The nail allows sliding of the Lag Screw to the lateral side for dynamic bone compression at the fracture sight to enhance fracture healing.

Technical Specifications

- Lag Screw diameter: 10.5mm
- Lag Screw lengths: 70–120mm in 5mm increments
- Patented Lag Screw design for high load absorption and easy insertion
- Asymmetrical depth profile to allow the Lag Screw to slide in the lateral direction only (see orange arrow on Fig. 4).
- Patented self retaining Set Screw to protect the Lag Screw against rotation and simultaneously allowing sliding of the Lag Screw laterally.

Fig. 4
Lag Screw Stabilisation System

Implant Features

Distal Locking Screws

The distal Locking Screw has a short self-tapping tip which facilitates a faster and easier start as well as easy screw insertion. It promotes excellent surface to bone contact (Fig. 5).



Fig. 5

The screw has an external diameter of 5mm, and provides an even higher fatigue strength than the clinically successful 6.28mm Locking Screw of the regular Gamma™ and G /K Locking Nail System (data on file).

The screw diameter directly under the screw head has been reduced to prevent radial pressure that may cause micro fractures during screw insertion when the screw head reaches its final position. This reduction in diameter also improves the feel on the final tightening of the screw (Fig. 5a).

Length Definition of the Distal Locking Screw

The distal Locking Screw is measured from head to tip (Fig. 5b).

Technical Specifications

- Distal Locking Screw Diameter: 5mm.
- Distal Locking Screw lengths ranging from 25–50mm, in 2.5 and 5mm increments. Longer screws up to 120mm are available on request.
- Fully threaded screw design. Partially threaded screws are available on request.
- Self-tapping screw tip with optimized short cutting flutes.
- Optimized diameter under the head helps to prevent microfractures during insertion.

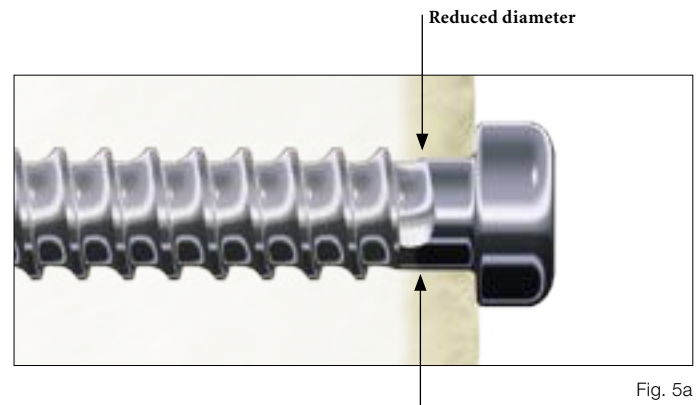


Fig. 5a

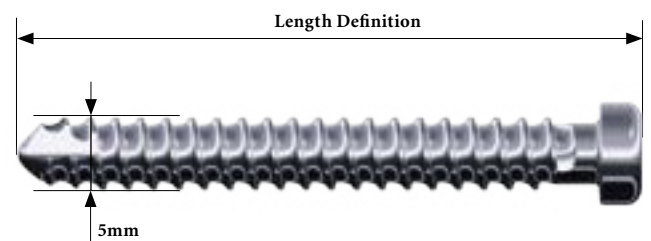


Fig. 5b

Implant Features

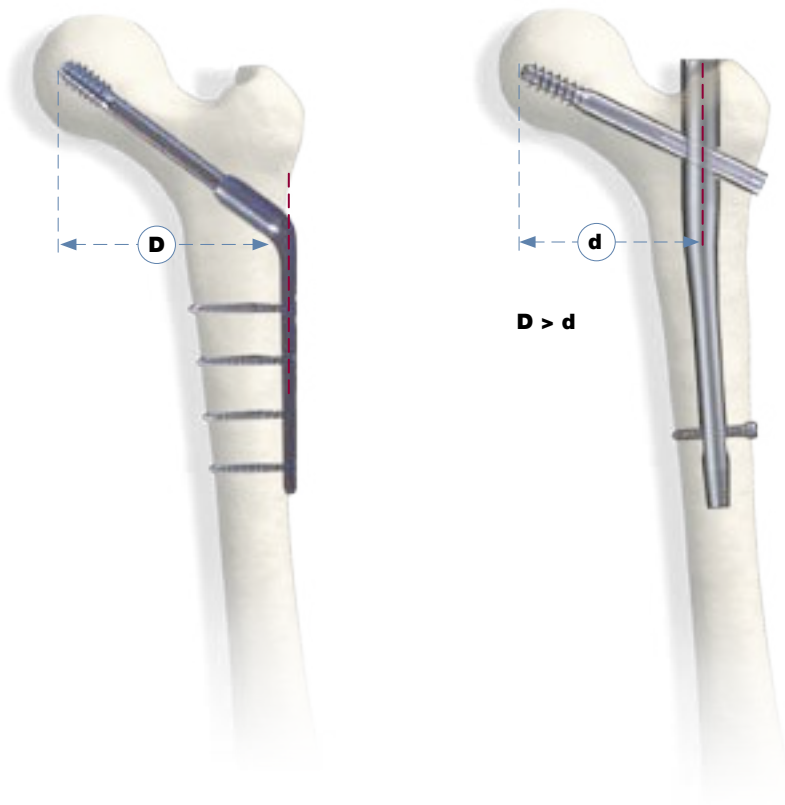


Fig. 6

Gamma3™ System Benefits

Strength and Stability

The biomechanical superiority of the intramedullary system offers significantly greater strength and stability compared with the side plate, in clinical use[1]. The new Gamma3 system offers the same strength as the well-established Gamma™ Locking Nail System.

The Biomechanical Advantage over Side-Plate Systems

Since the load-bearing axis of the Gamma3 Nail is closer to the hip joint fulcrum, the effective lever arm on the implant and femur is significantly shorter than with an extramedullary plate. The reduction factor is equivalent to d/D as shown in Figure 6 (approximately 25% [1]).

The resultant force is transmitted directly down the femur using a nail system. If a side-plate system is used, the femur shaft may be weakened through a high amount of locking screws. The Gamma3 Nail increases both the strength and reliability of the biomechanical repair. The distal dynamic locking option additionally allows the use of dynamic compression.

Rehabilitation Benefits

The extra strength effectively gained through the biomechanics of the Gamma3 System combined with improved control of axial telescoping and rotational instability may allow earlier weight-bearing even in patients with complex or unstable proximal fractures. Early mobilization, dynamic compression, and a less traumatic operative technique increase the chance for rapid recovery and reliable bone union.

[1] K.S.Leung et al, Multicenter Trial of the Modified Gamma™ Nail in East Asia CORR323: 146-154, 1996

Implant Features



Fig. 7

Indications / Contraindications

Indications

The indications for the Gamma3 Nail 180 are the same of those for the Gamma™ Trochanteric Locking Nail (Fig. 7).

- Intertrochanteric fractures
- Pertrochanteric fractures
- Nonunion and malunion

Contraindications

Contraindications are medial neck fractures and sub-trochanteric fractures.

Note:

If no bone consolidation occurs the system may fail. The aim of post-operative care must be to ensure the promotion of bone consolidation.

The aim of this operative technique manual is to provide the surgeon with a simple step-by-step operating guide to aid in successful addition of the Gamma3 System into their standard trauma care. Once the technique has been learned, the surgeon should find the operative procedure simple to implement. In fact, many of the basic principles for the Gamma3 System are those employed for all closed intramedullary nailing procedures.

This operative technique has been devised in consultation with leading surgeons in many countries to be a basic guide, particularly for less experienced users of the Gamma3 System. It is acknowledged that several alternative approaches to certain elements of the procedure are available, and may have advantages for particular situations or surgeons.

Operative Technique



Fig. 9
X-Ray in a-p view,
showing implant

Preoperative Planning

The Gamma3™ Nail with a 125° nail angle may be used in the majority of patients. The 120° nail may be needed in patients with osteoarthritic coxa vara, and the 130° nail for coxa valga.

Where such variations in femoral anatomy require an alternative, the following chapter describes how to select the optimum implant size.

Implant Selection

X-Ray templates are very helpful during preoperative planning. Use the X-Ray Templates for short and long nails to select the correct implant and the optimal nail angle.

These templates show the true implant size at a magnification of 15% in anterior-posterior view. The X-Rays should be taken at this magnification (15%) for an optimum surgical outcome (see Fig. 9). If accurate anatomical reduction has been achieved, the X-Ray can be taken from the fractured hip or from the contralateral side.

Alternatively the femoral neck angle, i. e. the angle between the femoral shaft mid-axis and the femoral neck mid-axis, could be measured using a goniometer.

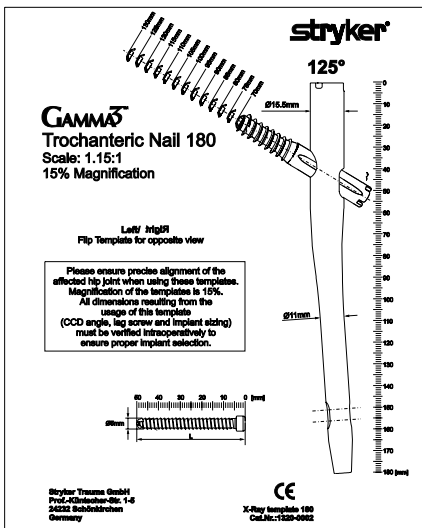


Fig. 9a
Gamma3 Nail 180 X-Ray Template
(Ref. No 1320-0002)

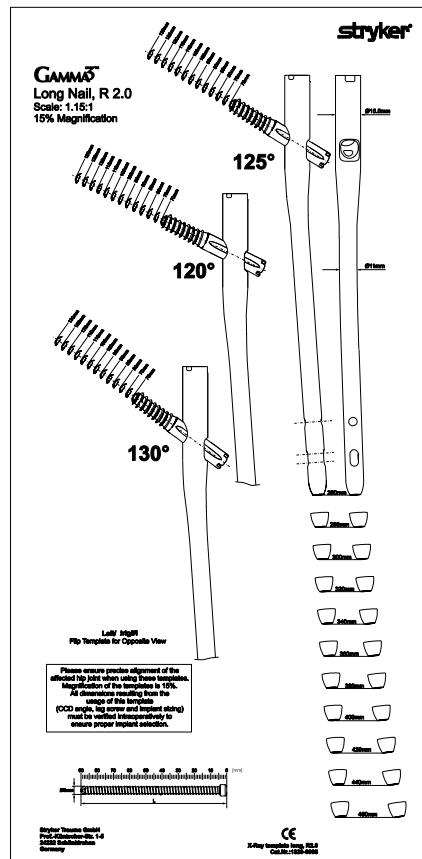


Fig. 9b
Gamma3 Long Nail X-Ray Template
(Ref. No 1320-0005)

Note:

Please ensure precise alignment of the affected hip joint when using these templates. Template magnification is 15%. All dimensions (nail angle and implant sizing) resulting from using these templates must be verified intraoperatively to ensure proper implant selection.

Operative Technique

Patient Positioning

The patient is placed in a supine position on the fracture table and closed reduction of the fracture is recommended. Reduction should be achieved as anatomically as possible. If this is not achievable in a closed procedure, open reduction may be necessary.

Traction is applied to the fracture, keeping the leg straight. The unaffected leg is abducted as far as possible to make room for the image intensifier (Fig. 10).

Maintaining traction, the leg is internally rotated 10–15 degrees to complete fracture reduction; the patella should have an either horizontally or slightly inward position (Fig. 11).

Position the image intensifier so that anterior-posterior and mediolateral views of the trochanteric region of the affected femur can be easily obtained. This position is best achieved if the image intensifier is positioned so that the axis of rotation of the intensifier is centered on the femoral neck of the affected femur (Fig. 12).

It is important to ensure that a view of both the distal and proximal ends of the nail can be obtained during the procedure without obstruction by the traction table.

The patient is then prepared and draped as for standard femoral nailing procedures. When positioning the drapes, bear in mind that the incision will be proximal.

Fracture Reduction

Note:

Reduction should be achieved as anatomically as possible. If this is not achievable, reduction should be achieved at least in one plane. Reduction in the other plane may be achieved with the Gamma3 Nail during insertion.

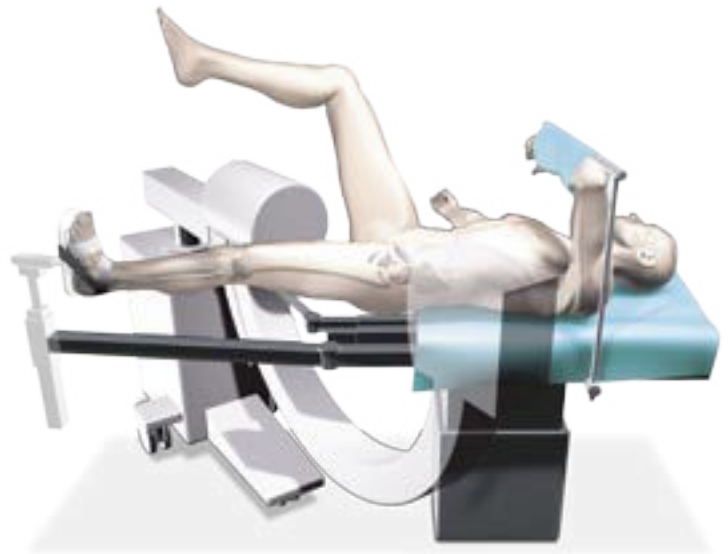


Fig. 10



Fig. 11

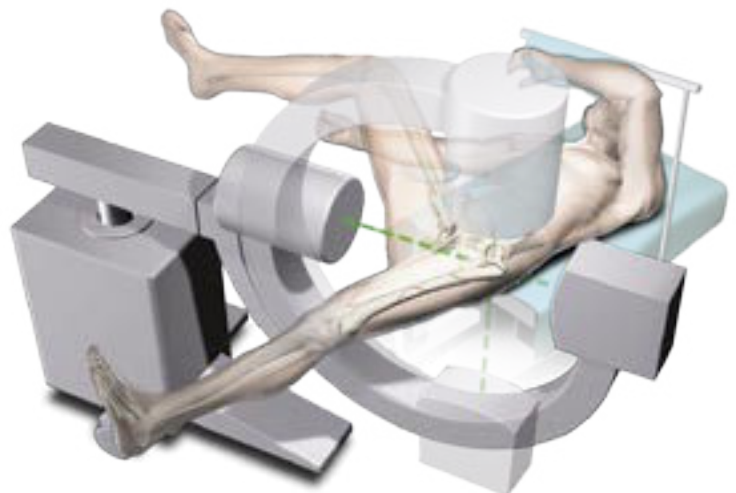


Fig. 12

Operative Technique



Fig. 13

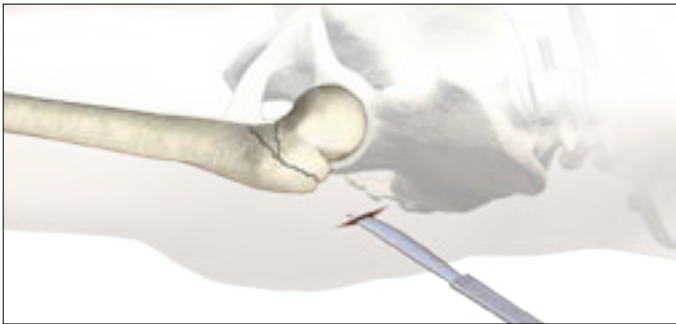


Fig. 14

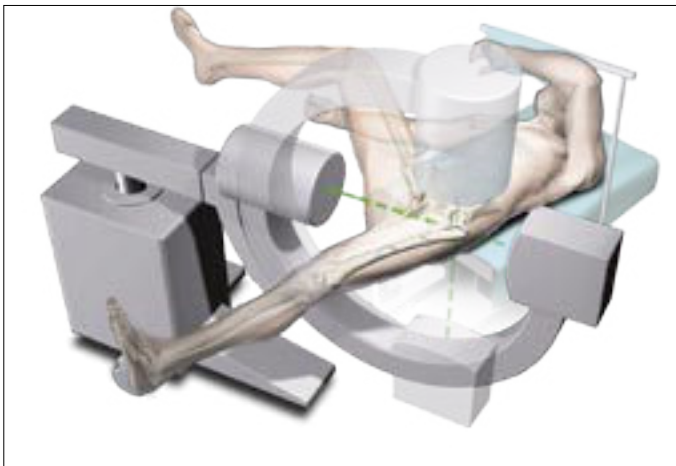


Fig. 15



Fig. 16

Incision

Incisions may be developed in different manners. Two alternatives will be described below.

Alternative 1:

The tip of the greater trochanter may be located by palpation (Fig. 13) and a horizontal skin incision of approximately 2–3cm is made from the greater trochanter in the direction of the iliac crest (Fig. 14). In obese patients the incision length may need to be longer, depending on obesity of the patient. A small incision is deepened through the fascia lata, splitting the abductor muscle approximately 1–2cm immediately above the tip of the greater trochanter, thus exposing its tip. A self-retaining retractor, or tissue protection sleeve is put in place.

Alternative 2:

A long and thin metal rod (e.g. Screw Scale, Long) is placed on the lateral side of the leg. Check with image intensifier, using l-m view, that the metal rod is positioned parallel to the bone in the center of the proximal part of the femoral canal (Fig. 16a). A line is drawn on the skin (Fig. 16).

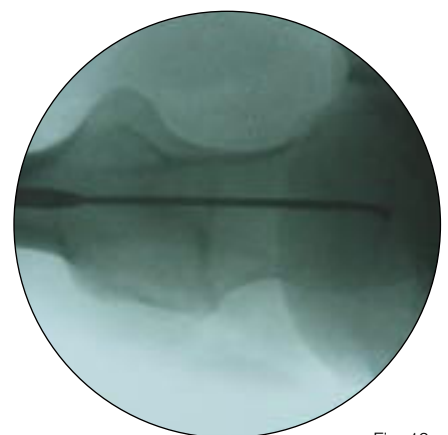


Fig. 16a

Operative Technique

The C-arm is turned approx 90° to provide an A-P image of the tip of the trochanter using the metal rod as shown in Figure 17 and 17a.

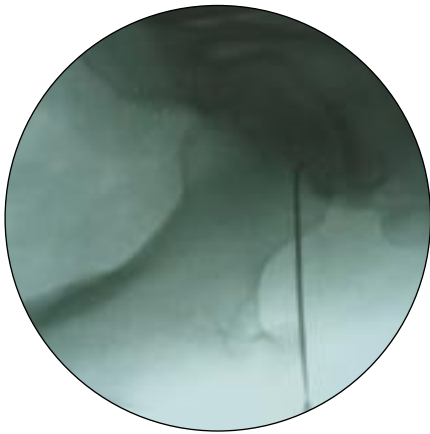


Fig. 17a

A vertical line is drawn onto the skin (Fig. 18). The intersection of the lines indicates the position for the entry point of the nail. This is usually the anterior third of the tip of the greater trochanter as shown in Fig. 22.

The skin incision is made cranially to the indicated intersection, following the sagittal line in cranial direction. The distance between the intersection and the starting point for the incision differs, depending on the obesity of the patient. Under normal conditions it is a distance of approximately 2cm's.

A small skin incision is made as described in Alternative 1 and shown in Fig. 20.

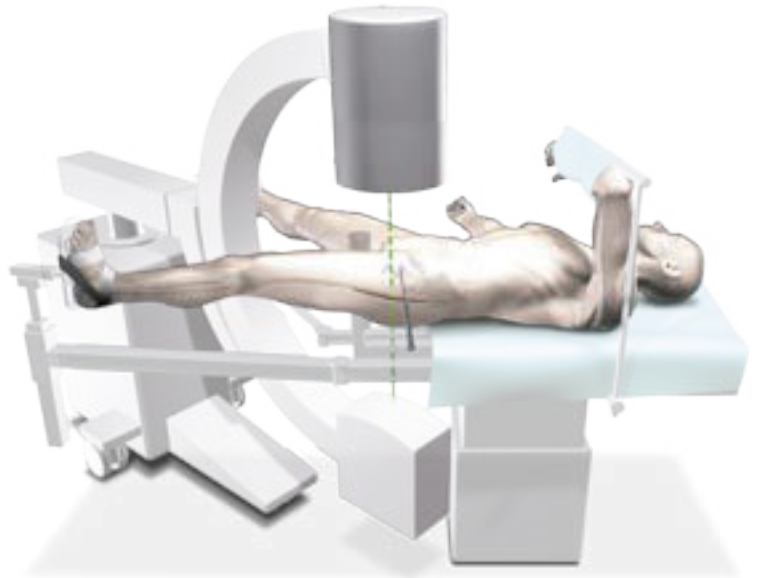


Fig. 17



Fig. 18



Fig. 19

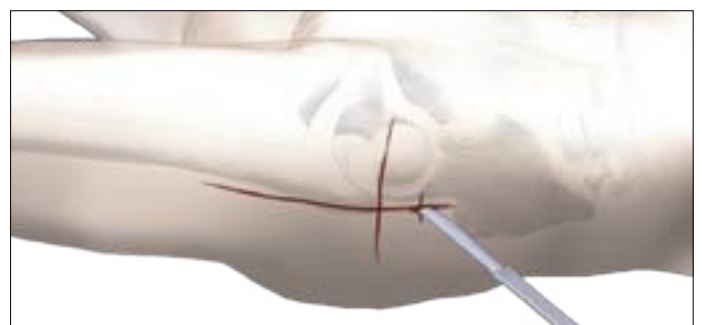


Fig. 20

Operative Technique



Fig. 21

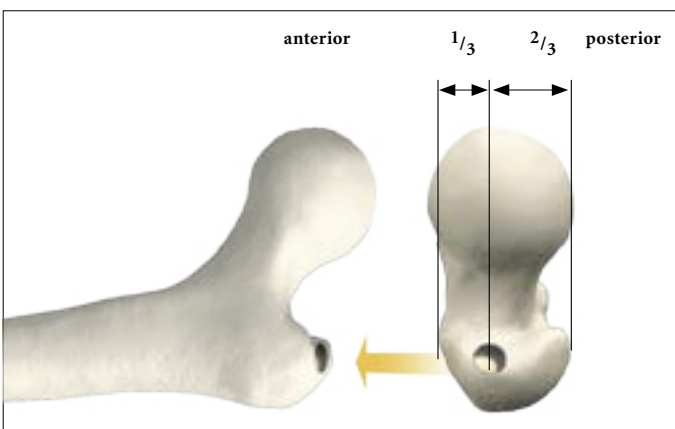


Fig. 22

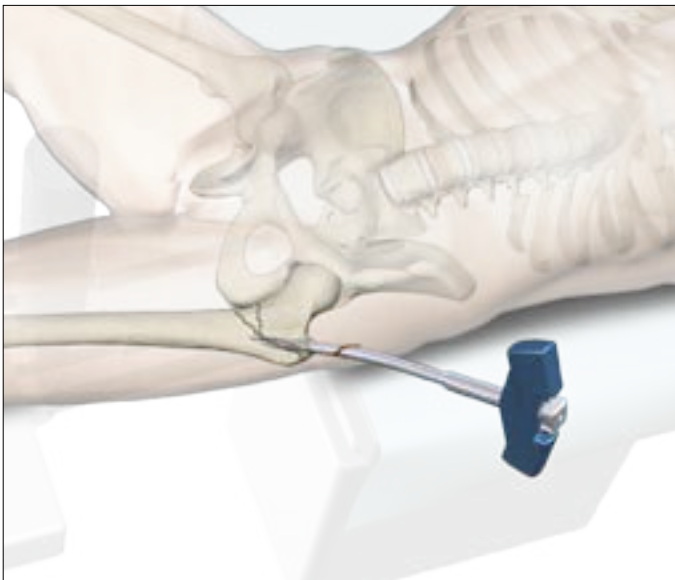


Fig. 23

Incision

Using a finger, the tip of the trochanter should be felt easily (Fig. 21).

Entry Point

The correct entry point is located at the junction of the anterior third and posterior two-thirds of the tip of the greater trochanter and on the tip itself (Fig. 22).

Preparation of the Medullary Canal

In order to prepare the medullary canal for the Gamma3 Nail 180, 3 possibilities are described in the next chapters.

Alternative 1: Opening the Cortex

The medullary canal has to be opened under image intensification. The use of the cannulated Curved Awl (Fig. 23) is recommended if conventional reaming or the One Step Conical Reamer will be used to prepare the canal for the nail.

Operative Technique

Reaming the Medullary Canal

A 3mm ball-tipped Guide-Wire is recommended as a reamer guide. Pass the reamer Guide Wire through the cannulated curved awl into the shaft of the femur as shown, using the Guide Wire Handle (Fig. 24).

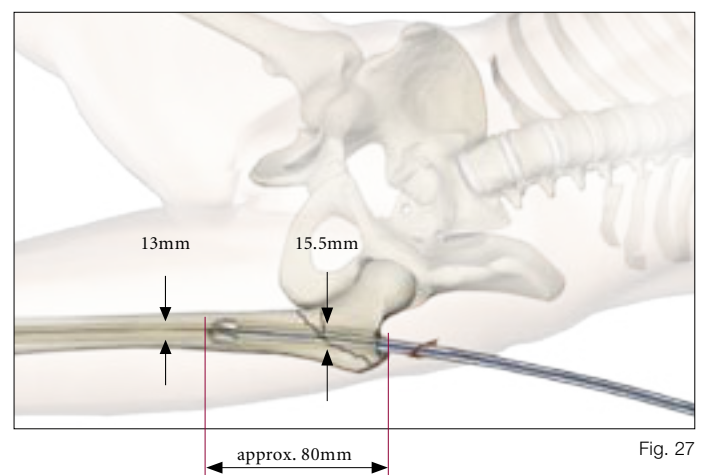
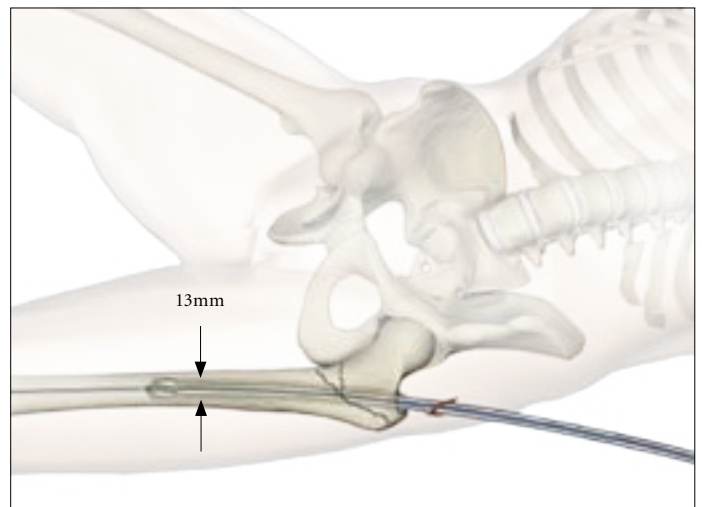
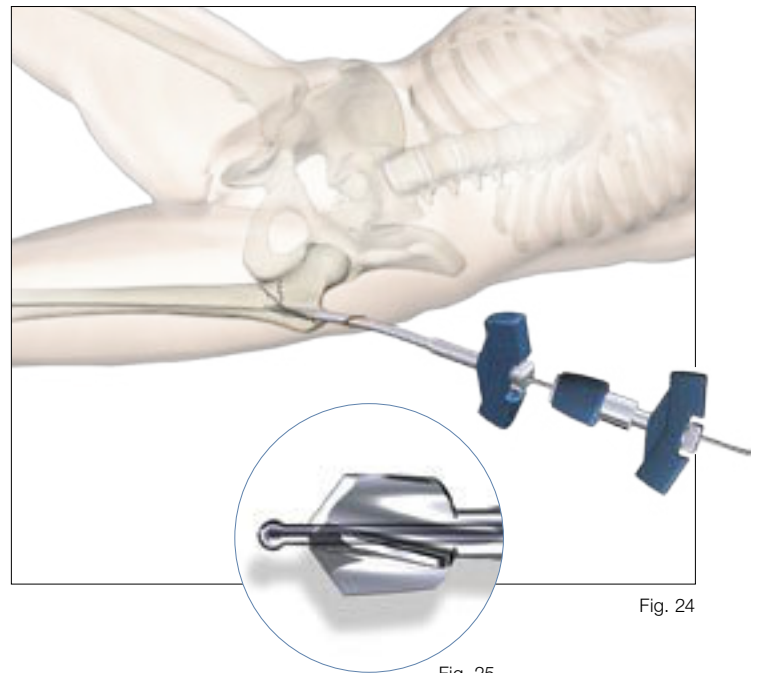
Rotating the Guide Wire during insertion makes it easier to achieve the desired position in the middle of the medullary canal.

Flexible reamers are used to ream the shaft of the femur in stages starting from 9mm diameter and increasing in 0.5mm increments (Fig. 25). The canal should be reamed at least 2mm larger than the distal diameter of the nail, 13mm for the Gamma3 Nail 180. In some narrow medullary canals, reaming may be necessary to achieve this (Fig. 26).

When reaming is performed, the entire femoral canal should be over-reamed down through the isthmus, in order to avoid stress riser in the bone.

In order to accommodate the proximal part of the Gamma3 Nail, the subtrochanteric region must be opened up to 15.5mm (Fig. 27). This can be done either by reaming with the Stryker BIXCUT™ Reaming System (Fig. 25) or, alternatively, with the One Step Conical Reamer. For soft tissue protection, the Conical Reamer Sleeve should be used during reaming.

Care must be taken with flexible reamers to ensure that the Guide-Wire is not displaced laterally during reaming. This could lead to resection of more bone on the lateral side, which in turn would lead to an offset position for the nail and a risk of shaft fracture.



Operative Technique



Fig. 28

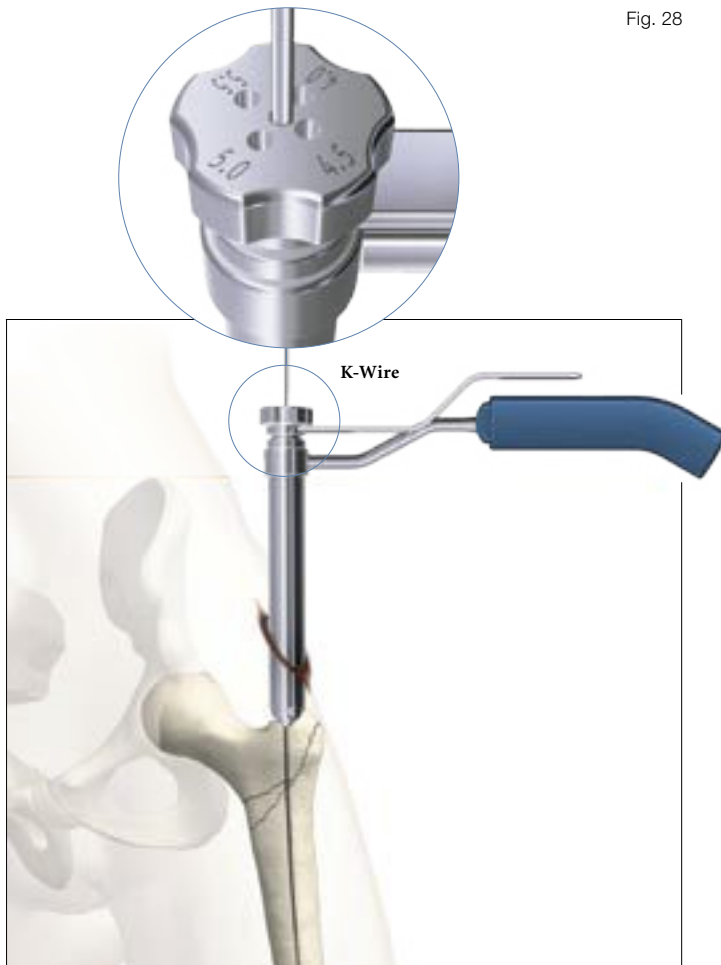


Fig. 29

Alternative 2: One Step Conical Reamer

The One Step Conical Reamer is an optional instrument and has been developed to provide surgeons with another option to prepare the proximal canal of the trochanter using only one drilling step.

When the Gamma3 Nail 180 is used, reaming of the subtrochanteric and diaphyseal region of the femoral cavity may not be required, particularly in elderly patients with wide medullary canals.

After skin incision and positioning of the Guide Wire as described above, the Trocar or Multi Hole Trocar is inserted into the Reamer Sleeve to protect the soft tissue during insertion. Push the Trocar (use center hole, if Multi Hole Trocar is used) and Sleeve Assembly down over the 3mm Guide Wire to the tip of the trochanter (Fig. 28 and 29).

Entry Point Optimization

The Entry Point can also be made without using the awl. A 3.2mm K-Wire is placed through the tip of the trochanter.

If you find that the K-Wire is not positioned in the optimal position, it may easily be corrected using a second K-Wire in combination with the Multi Hole Trocar.

The Multi Hole Trocar has a special design for more precise insertion. In addition to the central hole, 4 other holes are located eccentrically at different distances from the center (Fig. 29) to easily revise insertion of the guiding K-Wire in the proper position (Entry Point).

Operative Technique

The Trocar is then removed and the One Step Conical Reamer is connected to the T-Handle and slid over the Guide or K-Wire to the tip of the trochanter. With gentle clockwise turning and pushing movements, the Conical Reamer will drill into the proximal part of the trochanter (Fig. 30 and 31) and prepare the canal for the proximal part of the Gamma3 Nail. The One Step Conical Reamer stops when the correct depth is reached.

Note:

The One Step Conical Reamer is a front and side cutting instrument and should be used with great care to ensure that the sharp edges of the reamer do not damage intact bone inadvertently.

If a 3.2mm K-Wire was used it should be replaced by a Guide Wire now.

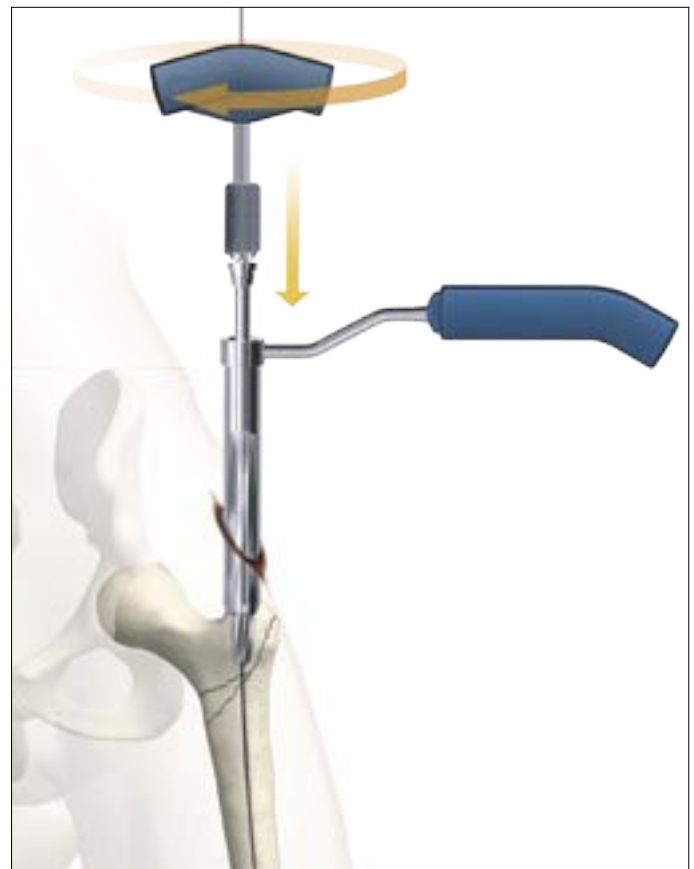


Fig. 30

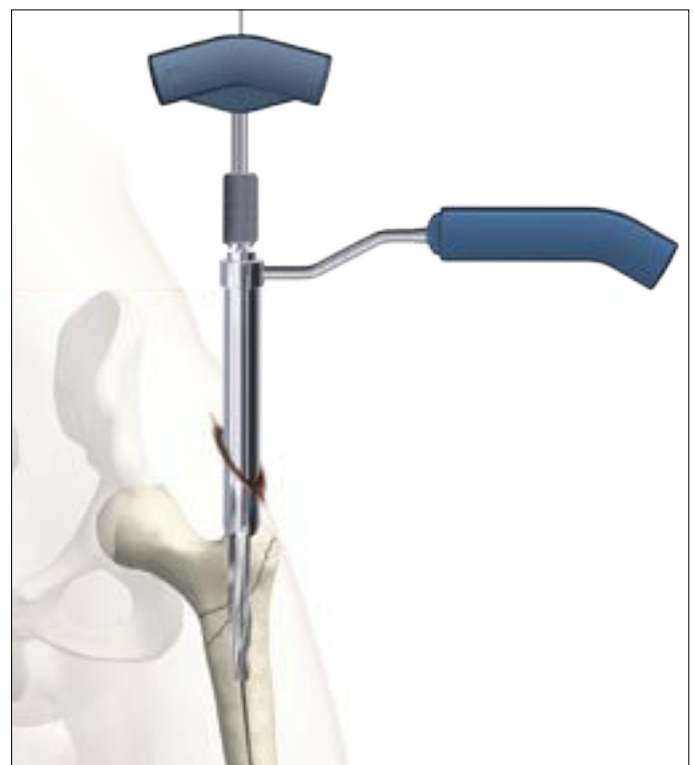


Fig. 31

Operative Technique



Fig. 32

Alternative 3: Cannulated Cutter

Opening the cortex

The Cannulated Cutter is a front cutting device used to prepare the proximal part of the femur for the Gamma3 Nail 180.

It provides surgeons with an advanced option to open the proximal femur cavity without reaming. Especially in older patients, it may reduce the requirement for reaming of the femoral cavity.

It is guided over a solid 4mm Guide Pin. The fixation of this Guide Pin in the bone allows for an optimal placement for the Cannulated Cutter. This device allows for easy collection of bone graft material which might be helpful in difficult healing conditions.

Its detailed operative technique is described separately (see Brochure "Cannulated Cutter" REF NO. B0300011).

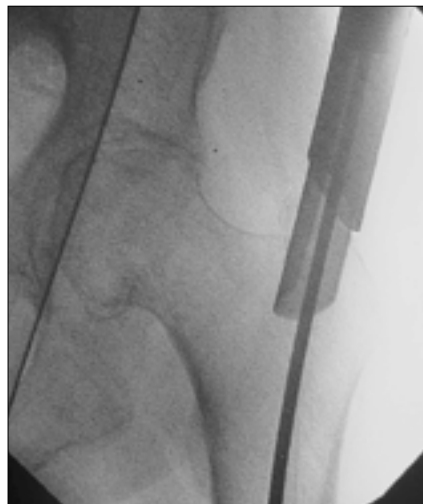
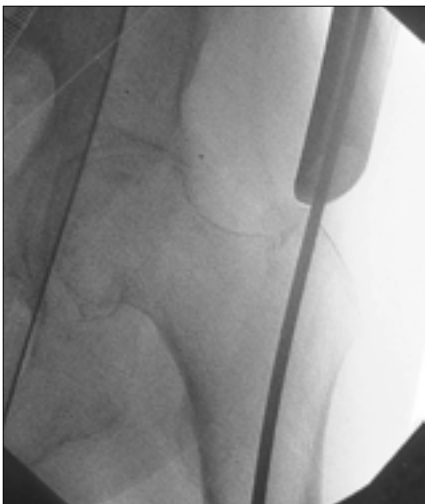


Fig. 33

Operative Technique

Assembly of Targeting Device

1. Targeting Sleeve and Knob Assembly

First assemble the Knob to the Targeting Sleeve (Fig. 34a) and adjust the point on the Knob to be in line with the arrow on the Target Sleeve. Push the knob hard against the sleeve. The Knob moves approximately 5mm to the sleeve and has to be turned clockwise by approximately 30 degrees. Now release the Knob and it will slip back the same distance. Now the Knob is assembled to the Targeting Sleeve and has to be connected to the Target Arm (Fig. 34c).

2. Target Arm and Targeting Sleeve Assembly

Push the Sleeve assembly over the Target Arm along the line until it stops (arrow line to arrow line).

Rotate the Targeting Sleeve around to the required nail angle position for the Lag Screw, e. g. 125° (point to point) or distal locking positions, either “Dynamic” or “Static”. Now the Targeting Sleeve must be fixed in this position by pushing it strongly against the Targeting Arm. You will feel and hear, as the sleeve snaps into position.

The Knob has only one function, this is to lock either the Lag Screw Guide Sleeve or the Tissue Protection Sleeve.

Note:

The Knob has to be assembled first to the Targeting Sleeve (Fig. 34a), otherwise the locking function of the sleeve may not work properly.

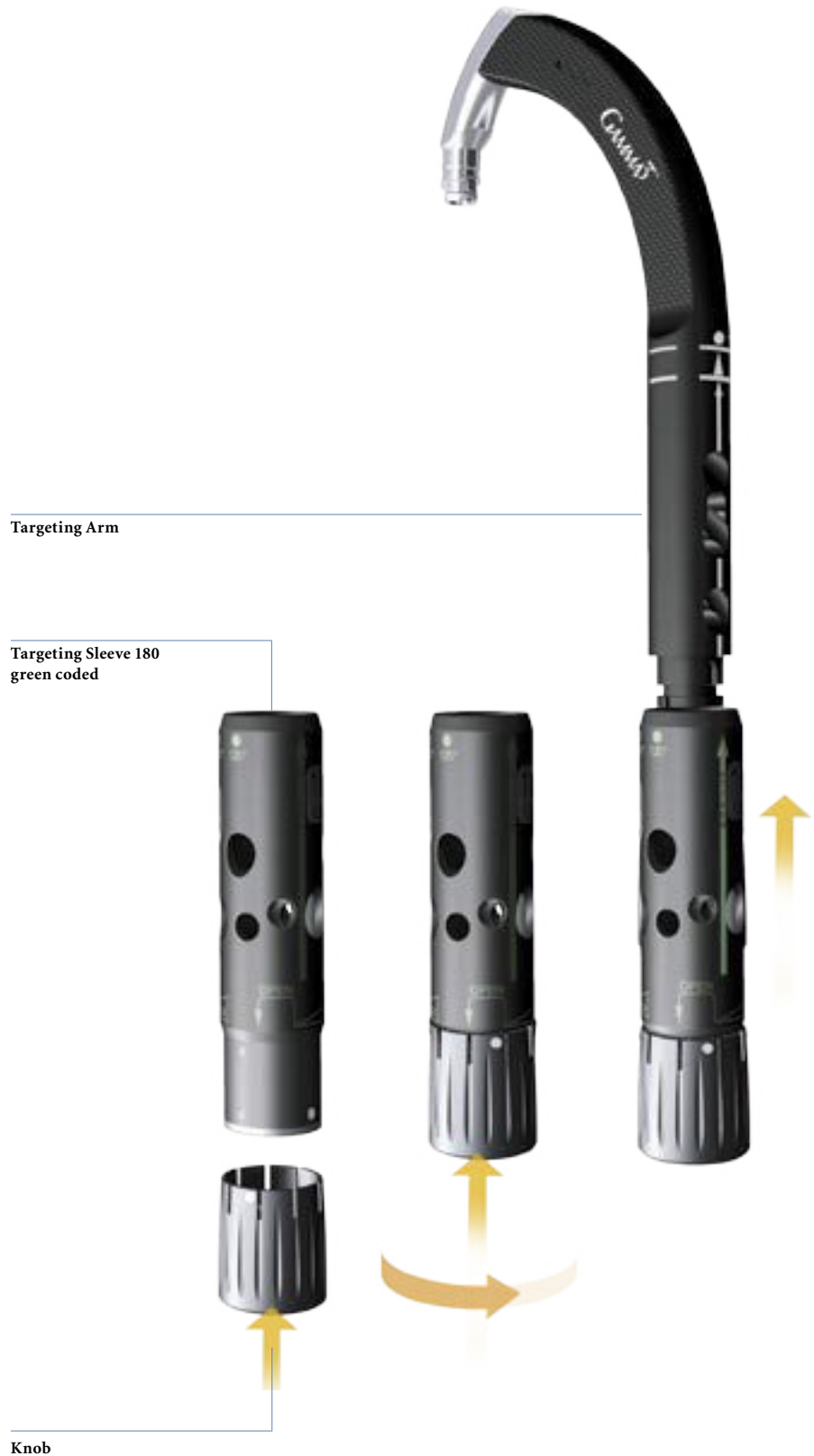


Fig. 34a

Fig. 34b

Fig. 34c

Operative Technique



3. Assembly of the Targeting Device and the Gamma3™ Nail 180

The selected Gamma3 Nail is now assembled to the Carbon Fibre Target Device as shown in Fig. 35. The nail connecting part of the Target Device is designed with an easy assembly function for fast and secure nail fixation. Ensure that the locating pegs fit into the corresponding notches of the proximal part of the nail.

Fully tighten the Nail Holding Screw with the Ball Tip Screwdriver, so that it does not loosen during nail insertion.

Before starting surgery the following functions of the Target Device have to be checked:

1. Secure fixation between Nail and Target Device
2. Lag Screw Guide Sleeve matches the selected nail angle.
3. Distal locking position of the Tissue Protection Sleeve, for required “Static” or “Dynamic” locking.

Fig. 35
Gamma3 Nail Assembly

Operative Technique

Before checking the function of the Lag Screw Guide Sleeve or Tissue Protection Sleeve for the distal locking, the Knob must be positioned in the counter clockwise position. Pass the Lag Screw Guide Sleeve gently through the hole of the Target Sleeve and tighten it gently in its final position, by turning the Knob clockwise. Check correct nail angle using the K-Wire, 4.2mm Drill or Lag Screw Step Drill (Fig. 36).

Removal of the Lag Screw Guide Sleeve in the opposite order; turn the Knob counter clockwise and remove the Lag Screw Guide Sleeve by pulling it back.

Before the distal locking function can be checked, the Target Sleeve has to be positioned in either the “Static” or “Dynamic” mode.

Pull the Target Sleeve back and turn the sleeve until the required distal locking position is reached. Now push the sleeve against the Target Arm until a “snap in” is felt.

The distal Tissue Protection Sleeve is passed through the Target Sleeve until its final position is achieved. Lock the distal Tissue Protection Sleeve by gently turning the Knob clockwise. Check position with the Drill Sleeve and 4.2mm Drill (Fig. 36a).

Note:

Before starting surgery, the implant and instrument assembly must be checked. Ensure that the Sleeve angle matches the corresponding nail angle chosen, e. g. a 125° Target Sleeve for a 125° nail, and the distal Sleeve matches either for “Dynamic” or “Static” locking as required (Fig. 36 and 36a).



Fig. 36



Fig. 36a
Checking of Lag Screw Sleeve and Distal Locking Sleeve positioning and function.

Operative Technique



Fig. 37

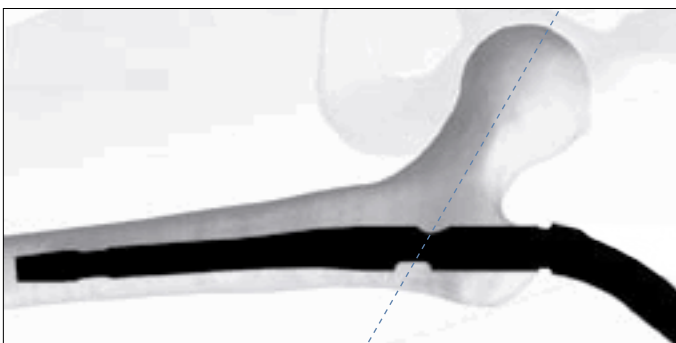


Fig. 38



Fig. 39a



Fig. 39

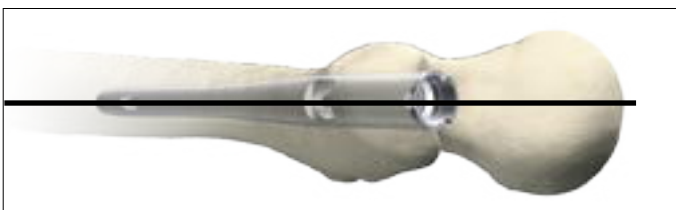


Fig. 40

Nail Insertion

Insert the Gamma3 Nail by hand (Fig. 37).

Do NOT use undue force – NEVER use a hammer for nail insertion.

The final Nail depth position is monitored with the image intensifier C-arm; the projected axis of the Lag Screw may be projected with a ruler on the monitor screen to ensure that the Lag Screw is placed in the optimal position.

Proceed until the axis of the Lag Screw hole (visible as a crescent shape on the screen) is aligned with the lower half of the femoral neck (Fig. 38). The objective of this is to ultimately position the Lag Screw centrally or slightly inferior in femoral head in the frontal plane.

Note:

Remove Guide Wire for the flexible reamer and nail insertion using Guide Wire Handle. (Fig. 39a).

When the Gamma3 Nail has been inserted to its final depth, check the anteversion of the nail. Use of the K-Wire Clip (Fig. 39) or the “One Shot Device” is recommended (see next page).

Before proceeding ensure that the Nail Holding Screw is still fully tightened.

The K-Wire Clip is mounted into the slots of the Target Arm by pressing the Clip flanges together.

The Lag Screw should be placed in the central position of the femoral head in the lateral view (Fig. 40).

Operative Technique

Lag Screw Positioning using the One Shot Device

The One Shot™ Device is recommended for optimal Lag Screw placement:

The One Shot™ Device is recommended, for establishing whether the Lag Screw is in the optimum position. This device enables correct positioning of the K-Wire for Lag Screw placement before performing lateral skin incision and opening of the lateral cortex (see Fig. 41–42a). Detailed steps are described in the separated Operative Technique of the “One Shot Device”(see Brochure “One Shot Device” REF NO. B0300010).

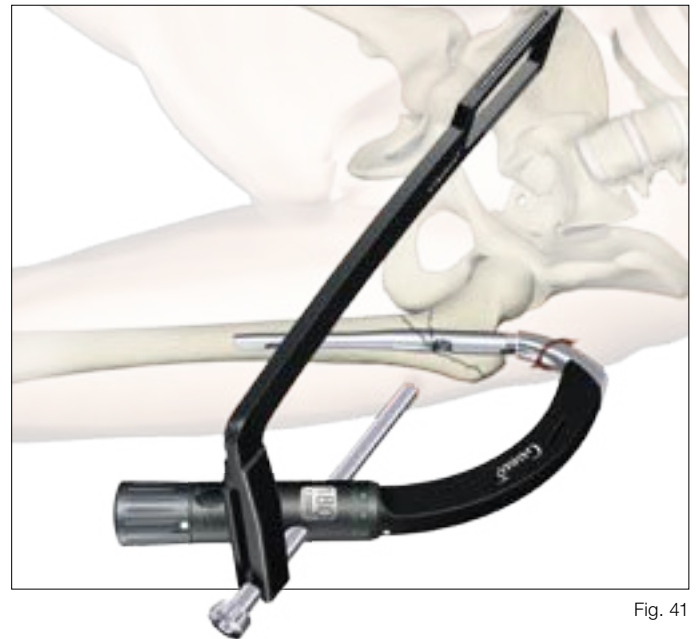


Fig. 41

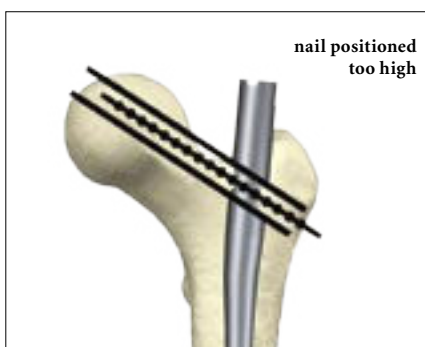
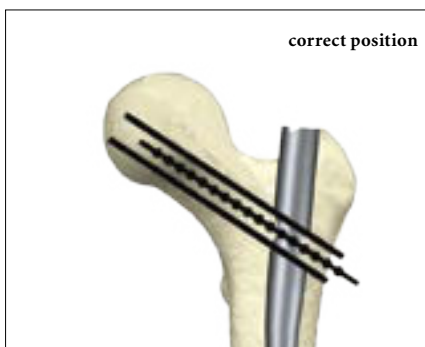
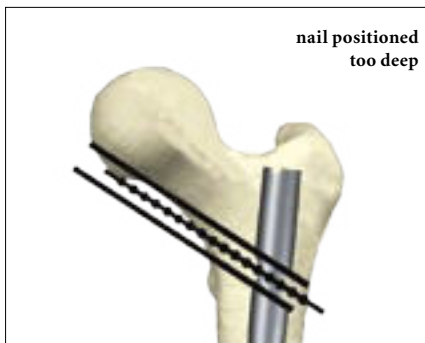


Fig. 41a
A/P view

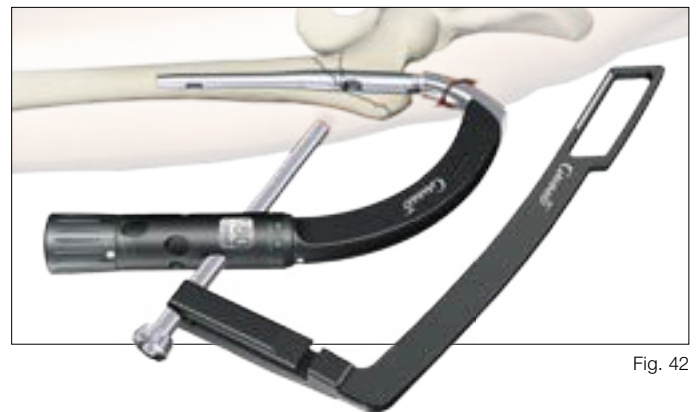


Fig. 42



Fig. 42a
Lateral view

Operative Technique

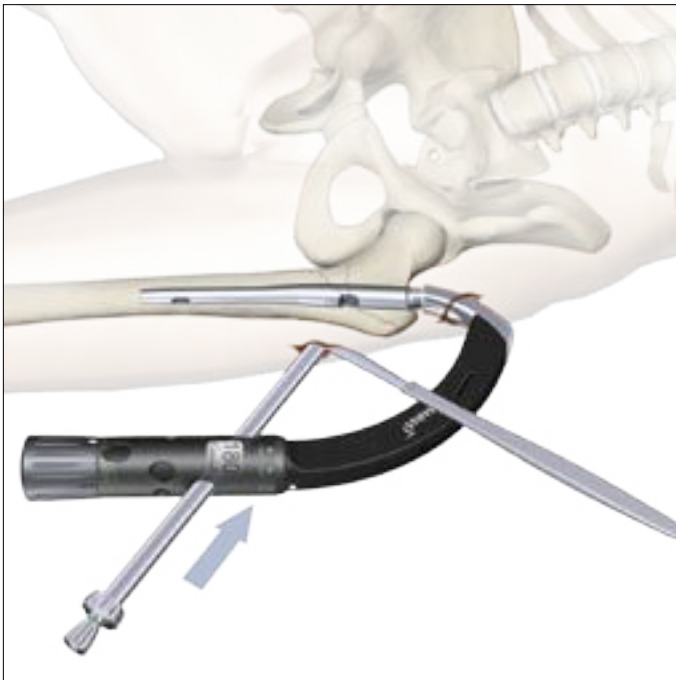


Fig. 43

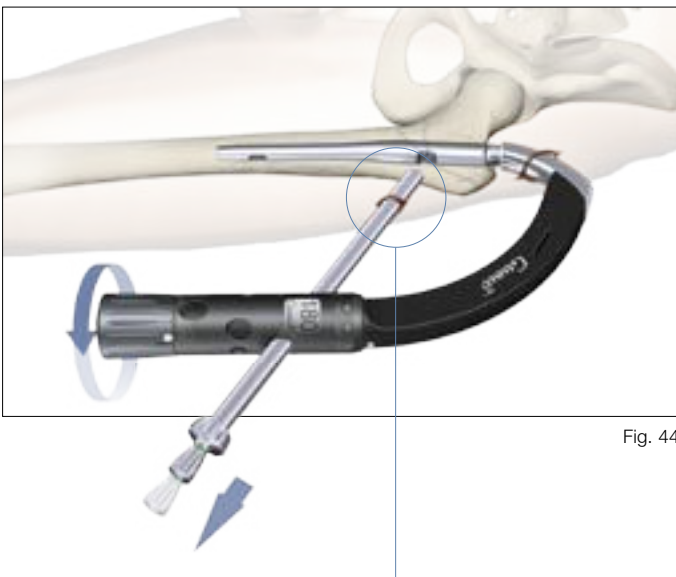


Fig. 44



Fig. 44a

Lag Screw Guide Sleeve in good contact to the lateral cortex

Lag Screw Insertion

The Targeting Device may be held by an assistant to prevent its weight from externally rotating the nail until the next stage is completed.

Next, assemble the Lag Screw Guide Sleeve with the green coded 4.2mm Lag Screw Drill Guide Sleeve and pass them through the Targeting Sleeve to the level of the skin. This indicates the position for a small incision down to the bone (Fig. 43). The Guide Sleeve assembly is now advanced through the incision. If the guide catches the fascia lata, twisting it will usually allow it to pass through to the bone.

In order for an accurate Lag Screw length measurement, the outer Guide Sleeve must be in good contact to the lateral cortex of the femur. The Knob of the Target Sleeve must be turned gently **clockwise** to lock the Guide Sleeve in place and further stabilize the targeting assembly (Fig. 44 and 44a).

Operative Technique

With the Lag Screw Guide Sleeve firmly engaged in the cortex, the green coded 4.2mm Lag Screw Drill Guide Sleeve should be pushed gently against the cortex. Using the green coded 4.2mm × 300mm center tipped drill, the lateral cortex should be opened by power tool or by hand (Fig. 45).

The green coded 4.2mm Lag Screw Drill Guide Sleeve is then replaced by the K-Wire Sleeve.

(Both sleeves look similar, but have different inner hole diameters. The K-Wire Sleeve has no colored ring).

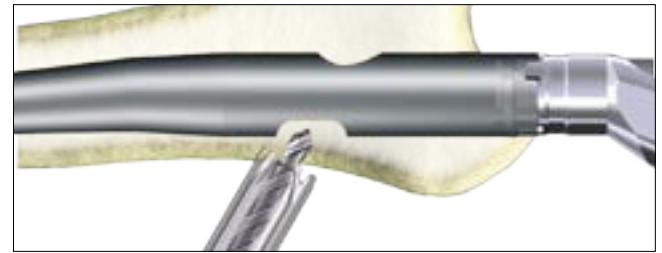


Fig. 45
Opening of the lateral cortex



Fig. 46
K-Wire placement

Note:
Before proceeding, check that the Guide Wire for the flexible reamer and nail insertion used earlier has been removed.

The single use K-Wire inserted through the K-Wire Sleeve should be advanced up to the subchondral bone (Fig. 46), using the Guide Wire Handle. Check that the K-Wire is placed either central or in the lower half of the femoral head in the frontal plane and on the midline in the lateral plane (Fig. 46a).

Check the position with the image intensifier in both the anterior-posterior and mediolateral views as shown in Fig. 38a to ensure optimal K-Wire positioning.

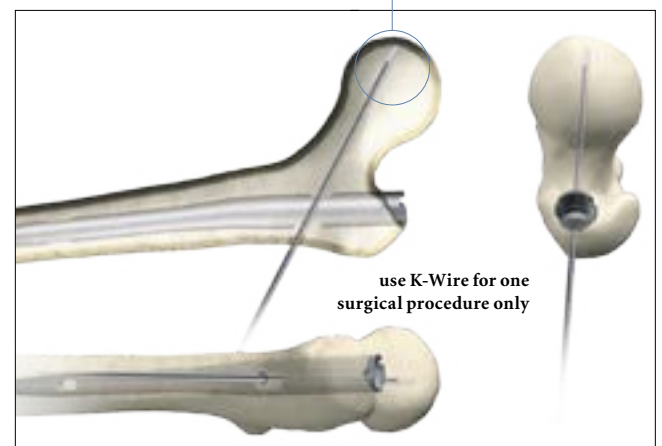
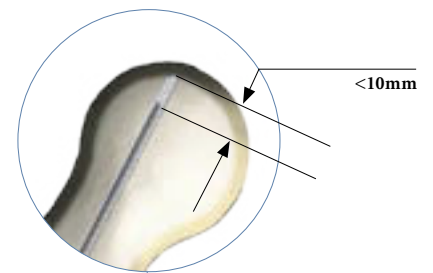


Fig. 46 a
K-Wire placement

Operative Technique

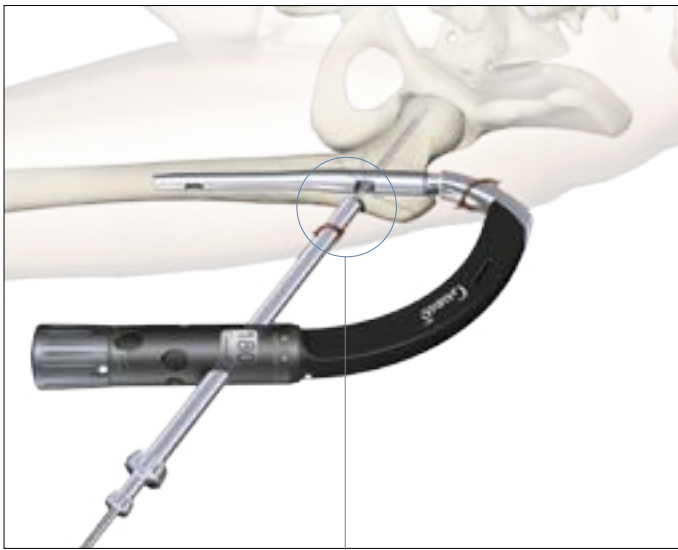


Fig. 47
Lag Screw length measurement

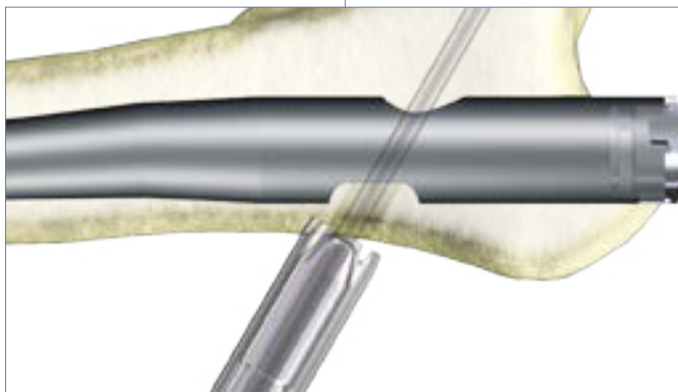


Fig. 47a



Fig. 48
Lag Screw Length Measurement

Lag Screw Insertion

The objective is to position the Lag Screw either in the center or below the center of the femoral head in the anterior-posterior view and centrally in the lateral view, to provide the best load transfer to the Lag Screw.

After satisfactorily positioning the K-Wire, the required Lag Screw length is measured using the Lag Screw Ruler.

Before starting to measure, ensure that the Lag Screw Guide Sleeve is still pressed firmly against the lateral cortex of the femur (Fig. 47a).

Place the Lag Screw Ruler directly under the K-Wire (Fig. 48).

The recommended value for the Step Drill depth and the Lag Screw length can be read directly from the Lag Screw Ruler. If the value is between markings on the scale, e. g. 97mm, it should always be rounded up to the next higher value, e. g. 100mm.

Note:

K-Wires are not intended for re-use. They are single use only. K-Wires may be damaged or bent during surgical procedures. If a K-Wire is re-used, it may become lodged in the drill and could be advanced into the pelvis, and may damage large blood vessels or cause other serious injuries.

Operative Technique



Fig. 49

The value of the measurement (Fig. 48) is now transferred to the adjustable stop on the Lag Screw Step Drill (Fig. 49).

The value e.g. 100 must be visible in the window (Fig. 49a)

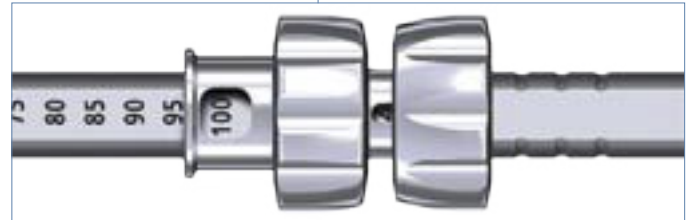


Fig. 49a

The K-Wire Sleeve is now removed and the adjusted Lag Screw Step Drill is passed over the K-Wire (Fig. 50), through the Lag Screw Guide Sleeve.

The channel for the Lag Screw is prepared using the T-Handle connected to the Lag Screw Step Drill. If exceptional resistance is encountered, a power drill may be used with great care.

Drilling should continue until the stop of the Step Drill comes into contact with the Lag Screw Guide Sleeve (Fig. 51). Ensure that the Targeting Device is well supported to prevent it from slipping back or rotating.

The drilling process, especially when the tip of the drill comes close to its final position in the femur head, should be controlled under an image intensifier to avoid hip joint penetration. The K-Wire also may be observed in the K-Wire window of the Step Drill.

Note:

It is important to observe the K-Wire tip during drilling on the intensifier. The K-Wire window provides an additional possibility to double check the K-Wire end position. Ensure that under no circumstances the K-Wire is advanced into the pelvis.



Fig. 50

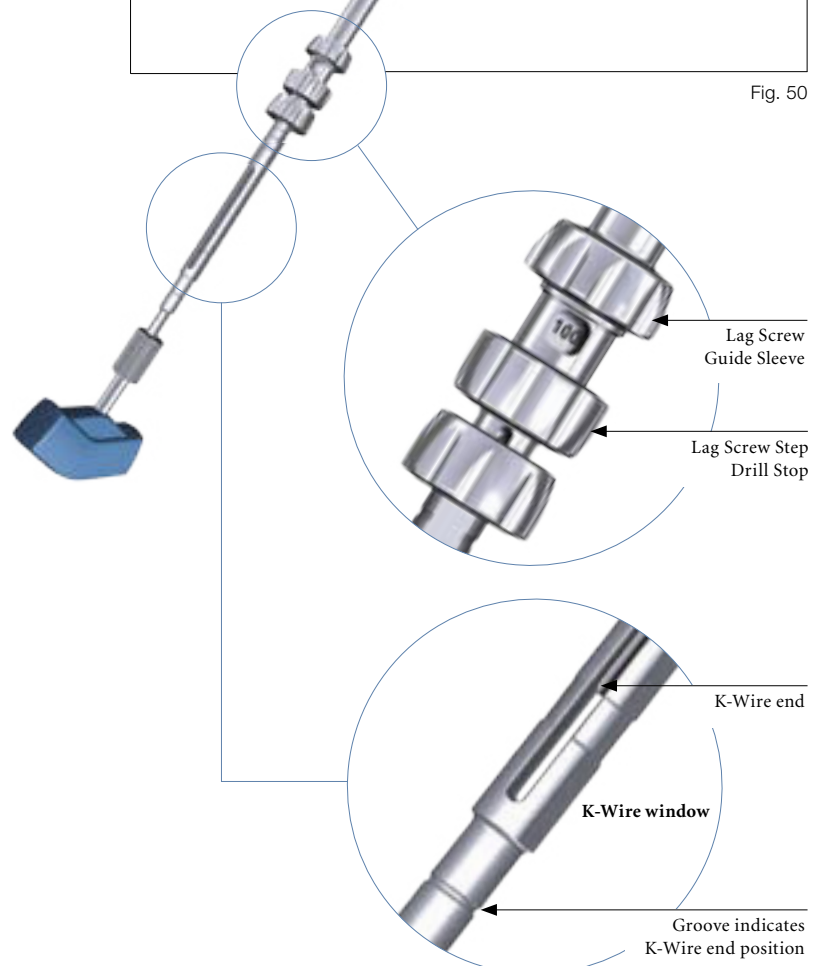


Fig. 51

Operative Technique

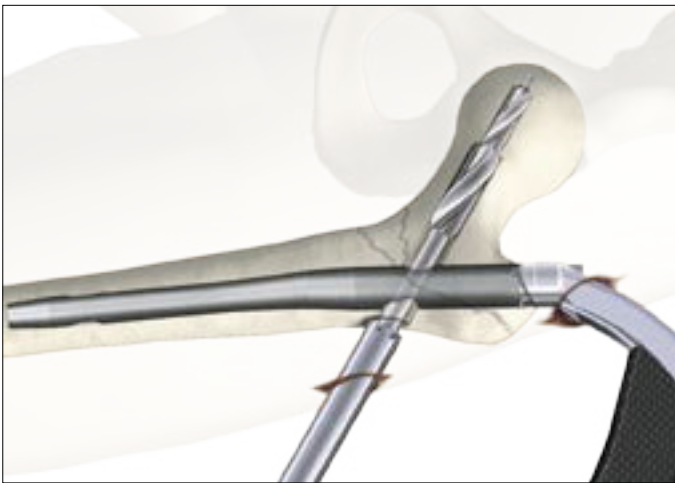


Fig. 52

Lag Screw Insertion

Check on the image intensifier during drilling to monitor the depth of the drill near the subchondral bone. At this stage, you should see the tip of the K-Wire protruding about 6 to 10mm out of the step drill. This is because the threaded portion of the K-Wire was intentionally not included in the drill measurement. This is to prevent the drill from penetrating the joint (Fig. 52) and to ensure that the K-Wire remains anchored in the subchondral bone after reaming. Remove the Step Drill by turning it clockwise and pulling it backwards.

The length of lag screw chosen should be the same as that of the Step Drill (in this example 100mm). The screw is then assembled to the Lag Screwdriver (Fig. 53).



Fig. 53
Lag Screw and Lag Screwdriver assembly

In a case where compression is to be applied, a shorter Lag Screw length should be chosen to avoid the end of it sticking out too far in to the lateral cortex (see chapter Compression/ Apposition below). Ensure that the pins of the Lag Screwdriver are in the slots of the Lag Screw. The end thumbwheel must be turned clockwise and tightened using the Ball Tip Screwdriver.

The Lag Screw assembly is now passed over the K-Wire, through the Lag Screw Guide Sleeve, and threaded up to the end of the predrilled hole of the femur head. Check the end position of the Lag Screw on the image intensifier. A double check of the end position is also possible with the indicator ring on the Lag Screw Screwdriver when it reached the end of the Lag Screw Guide Sleeve.

Operative Technique

Lag Screw Fixation

The handle of the Lag Screwdriver must be either parallel or perpendicular (90°) to the Target Arm (Fig. 55 on next page) to ensure that the Set Screw is able to fit into one of the 4 Grooves of the Lag Screw shaft.

If the T-Handle is not perpendicular or parallel to the Target Arm, turn it clockwise until it reaches this position. NEVER TURN THE LAG SCREW COUNTER CLOCKWISE.

If the K-Wire is inadvertently removed, then the screw may still be inserted without it, provided that the Guide Sleeve is still in contact with the cortex.

Note:

It is strongly recommended to place the Lag Screw at the end of predrilled hole in order to provide maximal resistance against cut out. Never turn the Lag Screw counter clockwise after the final position is reached, because otherwise the Lag Screw may lose full bony surface contact to its tip.



Fig. 54

Compression / Apposition

If compression or apposition of the fracture gap is required, this can be achieved by gently turning the thumb-wheel of the Lag Screwdriver clockwise against the Guide Sleeve (Fig. 54). Before starting compression, make sure that the Lag Screw Guide Sleeve is unlocked to allow its free sliding. To unlock the Lag Screw Guide Sleeve, the Knob has to be turned counter clockwise. In osteoporotic bone care must be taken to prevent Lag Screw pullout in the femoral head. The Lag Screw should be chosen shorter depending on the expected amount of compression.



Fig. 54b

Operative Technique

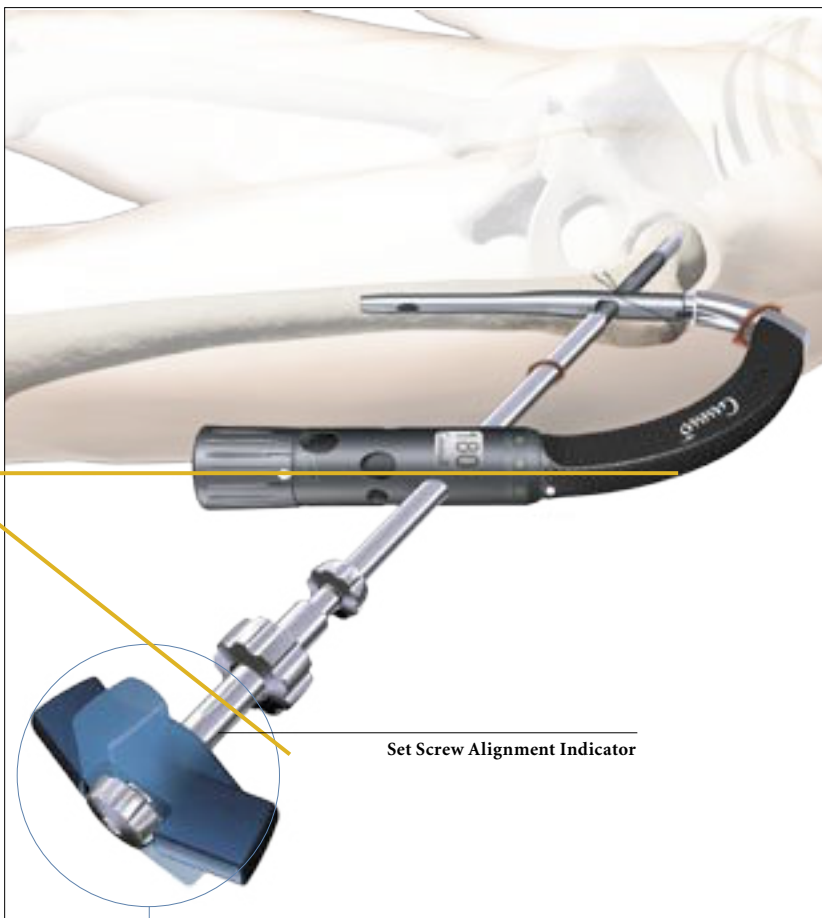


Fig. 55
T-Handle end position

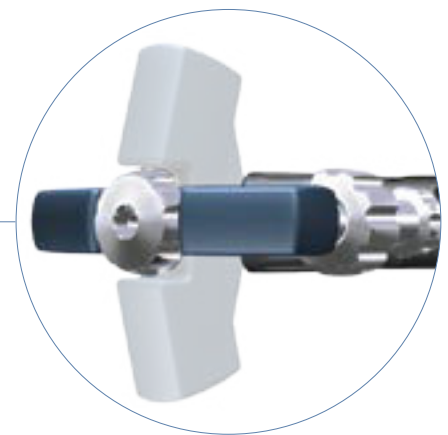
Lag Screw Fixation

Assemble the Set Screw to the Set Screw Driver. Insert the Set Screw as shown in Figure 56 along the opening of the post of the Targeting Device and advance it through the Nail Holding Screw pushing the Set Screwdriver.

Push the Set Screw Driver down until you are sure, that the Set Screw engages the corresponding thread in the nail. During pushing down the assembly, you may feel a slight resistance.

Turn the Screwdriver handle clockwise under continuous pressure. You may notice a slight resistance when turning the Set Screw. This is because the Set Screw thread is equipped with the “Nylstop” system to prevent spontaneous loosening. Turn the Set Screw until you feel contact in one of the grooves of the Lag Screw.

On slightly tightening the Set Screw, make sure that the handle of the Lag Screwdriver is either parallel or at right angles (90°) to the target arm (Fig. 55). The Set Screw alignment indicator will help to find the right position of the handle.



Operative Technique

This ensures that the Set Screw will engage in one of the four Lag Screw grooves (Fig. 57). To verify the correct position of the Set Screw, try to turn the Lag Screwdriver gently clockwise and counter-clockwise. If it is not possible to turn the Lag Screwdriver the Set Screw is engaged in one of the grooves. If the Lag Screw moves, recorrect the handle position and tighten the Set Screw again until it engages in one of the four grooves.

After slightly tightening the Set Screw it should then be unscrewed by one quarter ($\frac{1}{4}$) of a turn, until a small play can be felt at the Lag Screwdriver. This ensures a free sliding of the Lag Screw.

Make sure that the Set Screw is still engaged in the groove by checking that it is still not possible to turn the Lag Screw with the Lag Screwdriver.

Note:

Do not unscrew the Set Screw more than $\frac{1}{4}$ of a turn.

If distal locking is not indicated, the End Cap should be assembled to the nail end to prevent bone ingrowth. Leaving the Lag Screwdriver in place, the Nail Holding Screw is now removed using the ball tip Screw Driver or Universal Socket Wrench and turning it counter clockwise. Insert the End Cap (size 0) using the Socket Wrench or the Ball Tip Screwdriver. The End Cap should be tightened slightly.

Please see chapter “End Cap Insertion”.

Alternatively the End Cap could also be inserted free hand after removal of the Target Device.

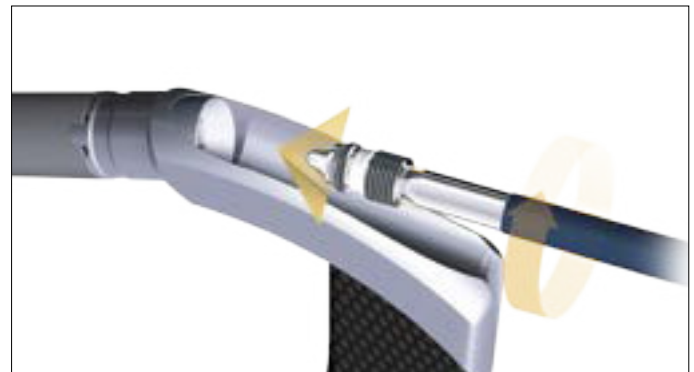


Fig. 56
Set Screw insertion

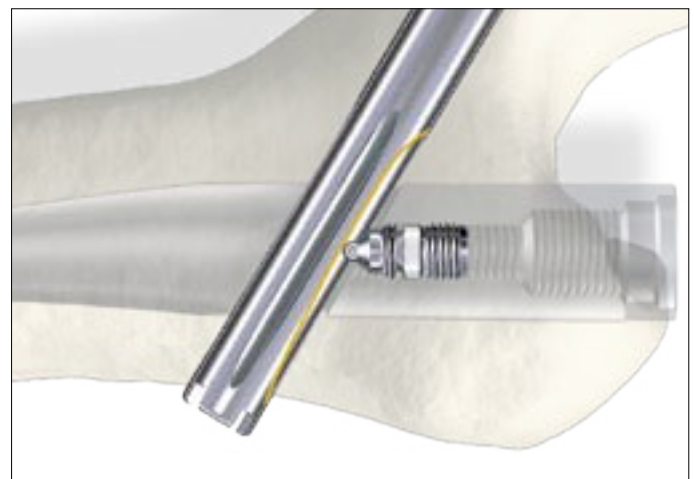


Fig. 57

Operative Technique

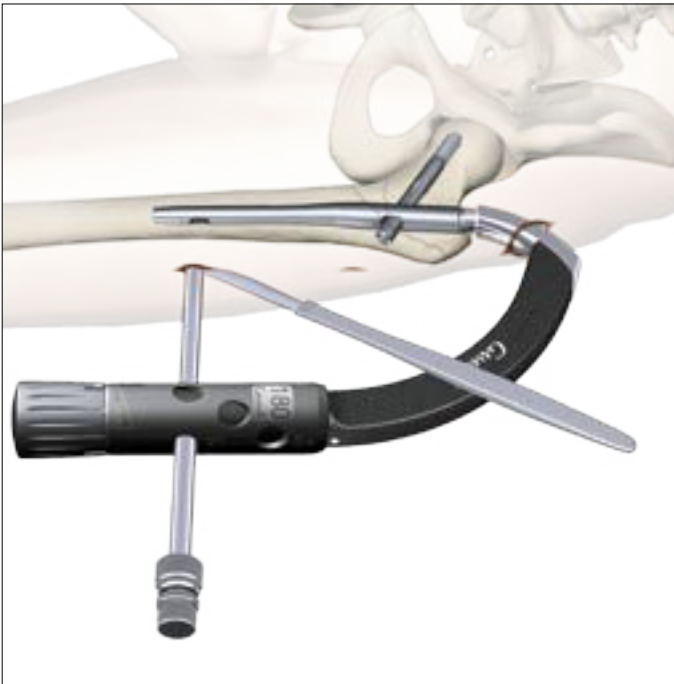


Fig. 58



Fig. 59

Distal Screw Locking

Disconnect the Lag Screwdriver by loosening the end thumbwheel, remove the Lag Screwdriver, Lag Screw Guide Sleeve and the K-Wire. The nature of the fracture determines whether the distal Locking Screw is used.

It should be used:

- If the fracture is unstable
- if rotational stability is required
- When there is a wide disparity between the diameter of the nail and the femoral cavity

Gamma3 nails offer the possibility to be locked distally either dynamically or statically. The fracture pattern determines the method of distal locking.

The Carbon Fibre Targeting Device offers the options of guided distal locking in a dynamic or static position of the nail. The green coded Targeting Sleeve of the Target arm has to be adjusted in the required position. In the following description, a dynamic locking will be described. Turn the Targeting Sleeve until you reach the dynamic position with the point on the Target Sleeve is in line with the arrow on the target arm. Push the sleeve up in the cranial direction. Now assemble the Distal Tissue Protector, Drill Guide Sleeve and Trocar and advance it through the hole of the target arm down to the skin.

A small incision is started at the tip of the Trocar, and is extended down to the lateral cortex (Fig. 58). The Trocar will extend back of the sleeve by approx. 3mm when the Tissue Protection Sleeve has reached the lateral cortex (Fig. 59).

Before locking the sleeve, gently turn the Knob clockwise, making sure that the Tissue Protection Sleeve is in good contact to the bone (Fig. 59).

Operative Technique

The Trocar is now removed and replaced by the calibrated green coded 4.2mm × 300mm drill. Drill through the first cortex and as the second cortex is reached read off the measurement on the drill scale. Add the thickness of the cortex, which is approximately 5mm, to this measurement to select the correct screw length (Fig. 60a).

Alternatively, the drill can be drilled through the second cortex and monitored by X-Ray or image intensifier. The screw length can then be **read directly** from the scale on the drill (Fig. 60a). Proceed to drill the second cortex.

It is also possible to measure the correct screw length using the Screw Gauge after drilling through the second cortex. The Drill Guide Sleeve must be removed and the Screw Gauge may be advanced through the Tissue Protection Sleeve. Put the small hook behind the medial cortex and read the required locking screw length from the scale.

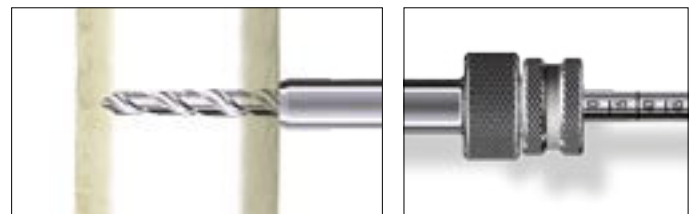
Insert the 5mm distal Locking Screw (Fig. 61) through the Distal Tissue Protector by using the 3.5mm Screwdriver until the mark on the Screwdriver shaft approaches the Protector; advance the screw head carefully until it is slightly in direct contact with the cortex (Fig. 60a).

Note:

When the mark on the Screwdriver shaft reaches the Tissue Protection Sleeve, this indicates that the screw head is near the cortex (Fig. 60a). Take care not to overscrew. The screw head should come just into contact with the cortex and resistance should be felt.

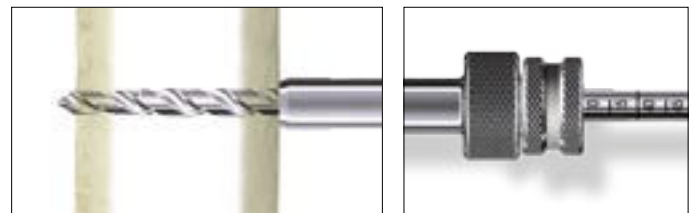


Fig. 60



+5mm

Fig. 60a



direct read out

Fig. 60b



Fig. 61

Operative Technique



Fig. 62
End Cap assembly

End Cap Insertion

It is recommended to use an End Cap to close the proximal part of the nail to prevent bone ingrowth.

Leave the Screwdriver for the distal locking in place and remove the Nail Holding Screw using the Ball Tip Screwdriver, Universal Socket Wrench or Strike Plate. Load the End Cap (size 0) to one of the Screwdrivers and pass the assembly through the top of the Targeting Device down into the nail.

Turn the handle clockwise until it stops mechanically. Remove the Screwdriver, the distal Screwdriver and the distal sleeves and remove the Targeting Device in cranial direction.

Alternatively the End Cap could also be inserted free hand after removal of the Target Device.



Fig. 63
Final Nail assembly

Operative Technique

Nail Extension End Caps

If the proximal end of the nail is completely in the trochanter and cortical bone support is required at the end of the nail, End Caps in size +5mm and +10mm are available and can be assembled to the nail instead of the End Cap size 0. The proximal part of the nail will be elongated by 5mm or 10mm.

The elongation End Caps are assembled using the Strike Plate with the self retaining ring or Ball Tip Screwdriver. This can only be done if the Target Device is already removed from the nail.

Postoperative Care and Rehabilitation

Active and passive mobilization of the lower limbs may be started immediately. The injured limb should be kept elevated.

For stable fractures with dynamic locking, full weight-bearing walking may be started immediately. For unstable fractures with static locking, immediate full weight-bearing walking is allowed in fractures with good bone contact.

For fractures with poor bone contact due to comminution, partial weight-bearing walking is allowed for the first 6 to 8 weeks. Full weight-bearing walking can be commenced when there is a bridging callus formed as evident on the follow up X-Ray.



Fig. 64

Operative Technique

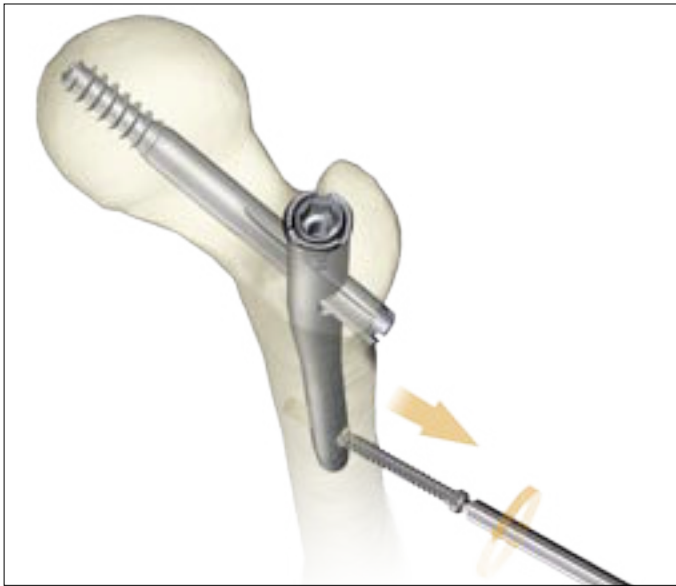


Fig. 65

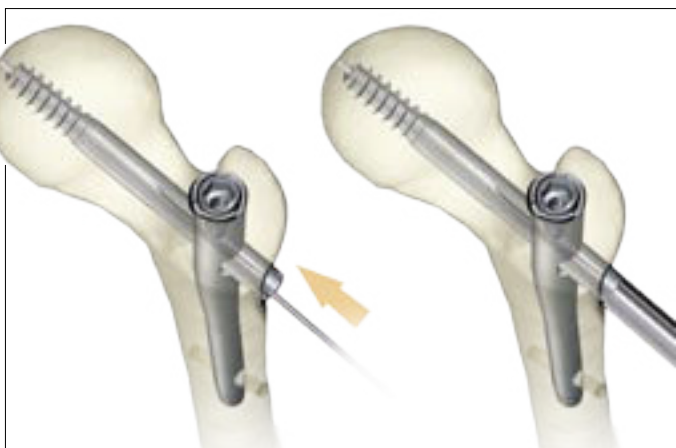


Fig. 66

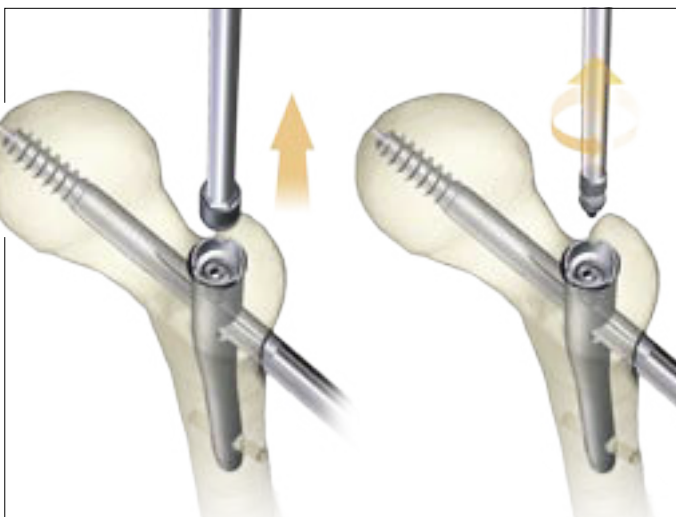


Fig. 67

Extraction of the Gamma3™ Implants

Where implant extraction is indicated, please proceed as follows:

Step I (Fig. 65)

Remove the distal screw using the 3.5mm Screwdriver after making an incision through the old scar.

Step II (Fig. 66)

Make a small incision through the old scar below the greater trochanter to expose the outer end of the Lag Screw. Remove any bony ingrowth which may be obstructing the outer end or internal thread of the Lag Screw as necessary to enable the Lag Screwdriver to engage fully, if end cap was placed.

The K-Wire is then introduced via the Lag Screw into the head of the femur. The Lag Screwdriver is passed over the K-Wire, using the Lag Screw Guide Sleeve as a Tissue Protector, and engaged with the distal end of the Lag Screw.

Check that ingrowth does not obstruct secure engagement of the Lag Screwdriver, otherwise the Lag Screw or Screwdriver may be damaged and extraction will be much more difficult. Tighten the thumb-wheel clockwise.

Step III (Fig. 67)

An incision is made over the proximal end of the nail, the proximal End Cap if used is removed using the Ball Tip Screwdriver or Strike Plate, and the Set Screwdriver is engaged with the Set Screw. The screw is rotated anti-clockwise until it is removed.

Note:

As the targeting device is not connected to the nail, we recommend using the Straight Set Screwdriver (1320-0210) for better guidance through the soft tissue to get access to the Set Screw.

Operative Technique

Step IV (Fig. 68)

The Conical Extraction Rod is then threaded and tightened into the proximal end of the nail. The Lag Screw is extracted by anti-clockwise rotation and pulling of the Lag Screwdriver. The K-Wire must then be removed.

Step V (Fig. 69a & b)

An appropriate sliding hammer assembly is attached to the Extraction Rod and the nail extracted.

Note:

It is a useful to turn the Lag Screw Screwdriver clockwise slightly first to loosen the possibly bony ingrowth into the screw threads before turning it counter clockwise.

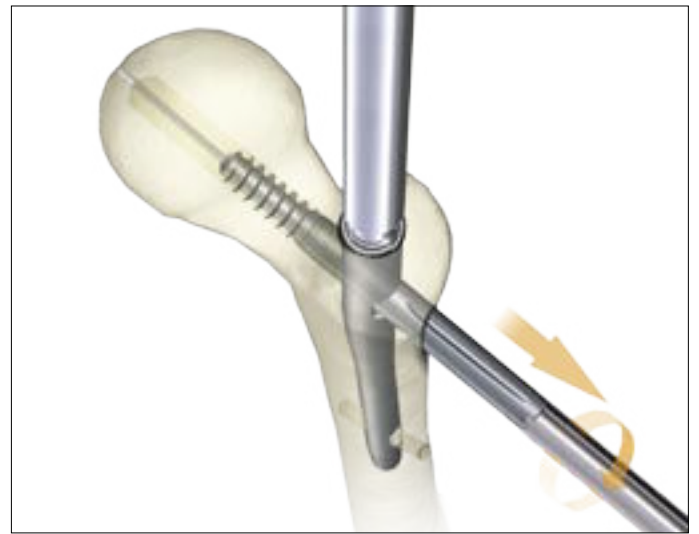


Fig. 68



Fig. 69a

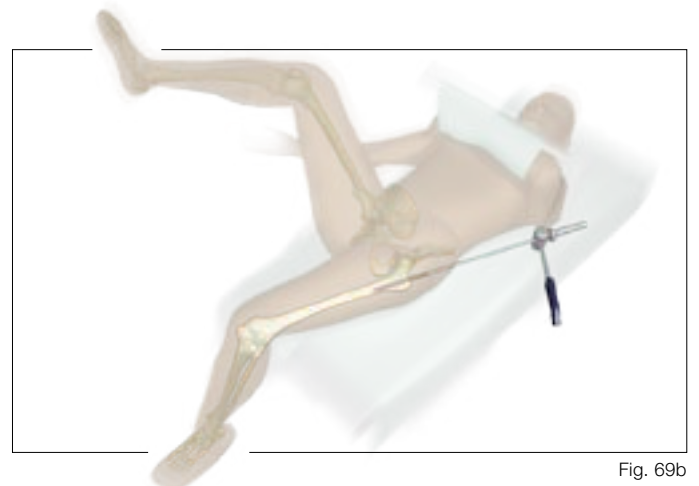


Fig. 69b

Operative Technique

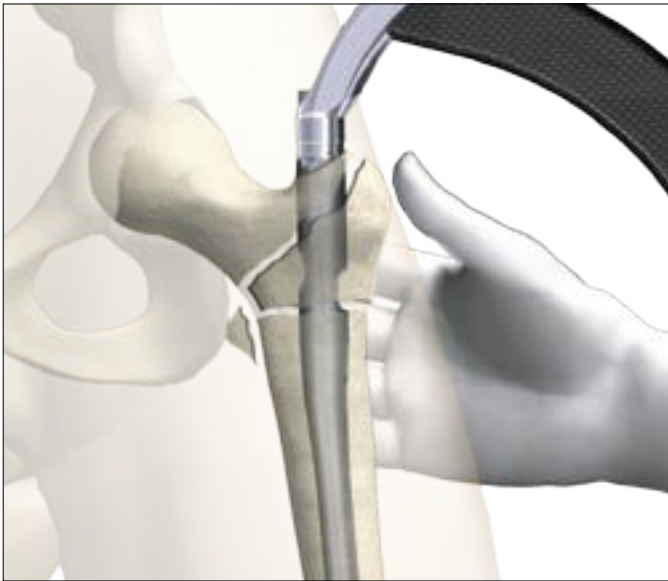


Fig. 70

Dealing with Special Cases





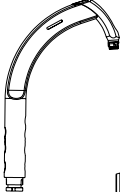



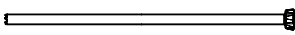

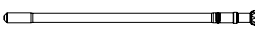

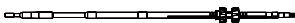


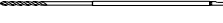
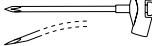


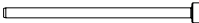




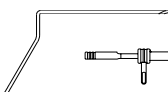
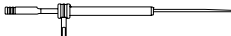


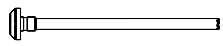



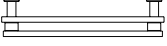



Posterior Displacement

In the case of a comminuted fracture, there is a tendency for the fracture to become displaced posteriorly, making it difficult to place the K-Wire into the center of the neck and head. This can be solved by lifting the nail insertion Targeting Device (Fig. 70).


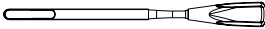



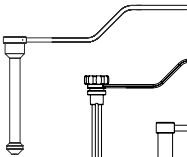
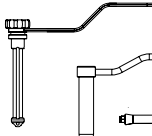
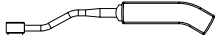
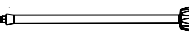
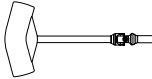

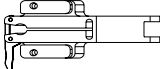


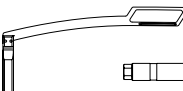





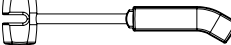
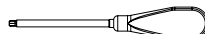
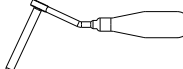



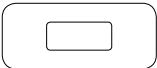
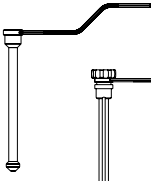
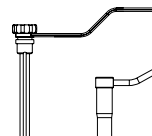
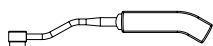
Alternatively, an assistant can lift up the greater trochanter manually or with a reduction spoon; or support it with a sandbag. This will maintain the neck and the femur in almost the same axis, facilitating passage of the K-Wire through the center of the neck and head.

The position should then be checked in both the anterior-posterior and lateral views using the image intensifier.

Ordering Information - Instruments

REF	Description
Basic Instruments	
	702628 T-Handle, Quicklock
	1210-6450S Kirschner Wire, sterile
	1320-0065 Screwdriver 8mm, Ball-Tip, T-Handle
	1320-0090 Nail Holding Screw
	1320-0100 Gamma3™ Targeting Arm
	1320-0105 Knob for Targeting Sleeve
	1320-0110 Clip for K-Wire
	1320-0118 Targeting Sleeve 180, green coded
	1320-0130 Lag Screw Guide Sleeve
	1320-0140 Drill Guide Sleeve 4.2mm for Lag Screw, green
	1320-0150 K-Wire Sleeve
	1320-0180 Lag Screw Ruler
	1320-0190 Lag Screw Step Drill
	1320-0200 Lag Screw Driver
	1320-0231 Flexible Set Screwdriver, 4mm, small shaft (silicon covered)
	1320-3042S Drill 4.2 × 300mm, AO small, green, sterile
	1806-0041 Awl, Curved
	1806-0095 Guide Wire Handle
	1806-0096 Guide Wire Handle Chuck
	1806-0185 Tissue Protection Sleeve, Long
	1806-0215 Drill Sleeve, Long
	1806-0232 Screwdriver, Long
	1806-0315 Trocar, Long
	1806-0325 Screw Gauge, Long
	1806-0365 Screw Scale, Long (for Long Nail)
	1806-0480 Screw Gauge (for Long Nail)
	1806-4270S Drill Ø4.2 × 180mm, AO small, green, sterile (for Long Nail)
	1320-9000 Instrument Tray, Basic, empty
	1320-6000 Instrument Set, Basic, completely filled
Not stored on the Tray	
	1320-0131 Lag Screw Guide Sleeve, navigated
	1806-0085S Guide Wire, Ball Tip, Ø3 × 1000, Sterile
	702634 Large AO Coupling Hall Fitting
	1320-0112 Gamma3 U-Wire
	1320-9002 Insert for Bixcut Reamer Heads for Diameter 11, 12, 13, 14, 15.5mm
	1806-0032 Trocar for Curved Awl, (Awl Plug)
	1320-0210 Straight Screwdriver, 4mm for Set Screw
	1320-3042 Drill 4.2 × 300mm, AO small, green, unsterile

Ordering Information - Instruments

	REF	Description
Optional Instruments		
	0152-0218	K-Wire 1.8 × 310mm, for Condyle Screws
	1320-0041	Cannulated Cutter, use with 4mm Guide Pin only
	1320-0042	Sleeve for Cannulated Cutter
	1213-9091S	Guide Pin 4 × 400mm, sterile
	1320-0011	One Step Conical Reamer, working with Conical Reamer Sleeve short and long
	1320-0021	Conical Reamer Trocar, short
	1320-0026	Multihole Trocar, short
	1320-0031	Conical Reamer Sleeve, short
	1320-0070	Screwdriver Strike Plate
	1320-0080	Universal Joint Socket Wrench
	1320-0135	Adaptor for One Shot Device, Gamma
	1320-0160	Fragment Control Clip
	1320-0170	Fragment Control Sleeve
	1320-3030S	Drill 3.0 × 300mm, AO small, sterile, white (for Fragment Control Clip)
	1320-3010	One Shot Device, Gamma3™
	1407-4006	Nail Extraction Adapter
	1806-0020	Guide Wire Ruler (for Long Nail)
	1806-0110	Universal Rod
	1806-0125	Reduction Spoon
	1806-0130	Wrench, 8mm / 10mm
	1806-0170	Slotted Hammer
	1806-0255	Condyle Screwdriver (for Condyle Screws)
	1806-0450	Tissue Protection Sleeve
	1806-0460	Drill Sleeve Ø4.2mm
	1806-4290S	Drill, 4.2 × 230mm, AO small, sterile, green (Long Nail)
	1806-5020S	Drill, 5 × 340mm, AO small, sterile, black (for Condyle or Shaft Screws)
	1320-9005	Instrument Tray, Optional
	1320-0022	Conical Reamer Trocar, long
	1320-0027	Multihole Trocar, long
	1320-0032	Conical Reamer Sleeve, long
X-Ray Template		
	1320-0002	X-Ray Template, Gamma3 Nail 180
	1320-0005	X-Ray Template, Gamma3 Long Nail, R 2.0

Implants



Fig. 71

Packaging

All implants are packed sterile only.

The Nail and Lag Screw Implant have to be secured using the Set Screw in every surgical operation, without exception (see also page 29).

The Nail and the Set Screw are therefore supplied together in the same blister pack (see Fig. 71).

The blister is packed in a white carton and wrapped to protect the contents during transportation and storage.

Only two package sizes are used for all the nails (Fig. 72).

The long nails are packed in a longer box and the short nails in a shorter box.

This facilitates identification in the storage area.

The package carries also the date of sealing and a sterility expiration date.



Long Nail, packaging example



Trochanteric Nail, packaging example

Fig. 72

Ordering Information - Implants

Trochanteric Nail Kit 180, Ti *



Titanium REF	Diameter mm	Length mm
3120-1180S	15.5/11	180 × 120°
3125-1180S	15.5/11	180 × 125°
3130-1180S	15.5/11	180 × 130°

5mm fully threaded Locking Screw, Ti **



Titanium REF	Diameter mm	Length mm
1896-5025S	5.0	25.0
1896-5027S	5.0	27.5
1896-5030S	5.0	30.0
1896-5032S	5.0	32.5
1896-5035S	5.0	35.0
1896-5037S	5.0	37.5
1896-5040S	5.0	40.0
1896-5042S	5.0	42.5
1896-5045S	5.0	45.0
1896-5050S	5.0	50.0

Lag Screw, Ti ***



Titanium REF	Diameter mm	Length mm
3060-0070S	10.5	70
3060-0075S	10.5	75
3060-0080S	10.5	80
3060-0085S	10.5	85
3060-0090S	10.5	90
3060-0095S	10.5	95
3060-0100S	10.5	100
3060-0105S	10.5	105
3060-0110S	10.5	110
3060-0115S	10.5	115
3060-0120S	10.5	120

End Caps, Ti



Titanium REF	Diameter mm	Length mm
3005-1100S	11.0	0
3005-1105S	15.5	+5
3005-1110S	15.5	+10

Set Screw, Ti (available separately)



Titanium REF	Diameter mm	Length mm
3003-0822S	8	17.5

* Nails are packed together with the Set Screw, sterile

** Longer Locking Screws as well as partly threaded screws are available on request.

*** Longer Lag Screws are available on request.

Ordering Information - Implants

Trochanteric Nail Kit 180, StSt *



Stainless Steel REF	Diameter mm	Length mm
4120-1180S	15.5/11	180 × 120°
4125-1180S	15.5/11	180 × 125°
4130-1180S	15.5/11	180 × 130°

5mm fully threaded Locking Screws, StSt **



Stainless Steel REF	Diameter mm	Length mm
1796-5025S	5.0	25.0
1796-5027S	5.0	27.5
1796-5030S	5.0	30.0
1796-5032S	5.0	32.5
1796-5035S	5.0	35.0
1796-5037S	5.0	37.5
1796-5040S	5.0	40.0
1796-5042S	5.0	42.5
1796-5045S	5.0	45.0
1796-5050S	5.0	50.0

Lag Screw, StSt ***



Stainless Steel REF	Diameter mm	Length mm
4060-0070S	10.5	70
4060-0075S	10.5	75
4060-0080S	10.5	80
4060-0085S	10.5	85
4060-0090S	10.5	90
4060-0095S	10.5	95
4060-0100S	10.5	100
4060-0105S	10.5	105
4060-0110S	10.5	110
4060-0115S	10.5	115
4060-0120S	10.5	120

End Caps, StSt



Stainless Steel REF	Diameter mm	Length mm
4005-1100S	11.0	0
4005-1105S	15.5	+5
4005-1110S	15.5	+10

Set Screw, StSt



Stainless Steel REF	Diameter mm	Length mm
4003-0822S	8	17.5

* Nails are packed together with the Set Screw, sterile

** Longer Locking Screws as well as partly threaded screws are available on request.

*** Longer Lag Screws are available on request.

References

Publications

More than 900.000 Gamma Nail implantations have been performed world wide over the last 16 years. Extensive clinical experience has been published with the Gamma™ Locking Nail.

We recommend the following publications:

- The Gamma Locking Nail, Ten Years Surgical Experience
Gahr, R. H.; Leung, K.-S.; Rosenwasser, M. P.; Roth, W. (eds.),
Einhorn-Press Verlag,
ISBN 3-88756-808-7
- Patients treated with the Long Gamma Nail, R. van Doorn,
Bedrijfsnaam: Castellum
Drukwerk Vof.

These books contain almost 300 clinical reports available on request.

Notes

Notes

Notes

Joint Replacements

Trauma

Spine

Micro Implants

Orthobiologics

Instruments

Interventional Pain

Navigation

Endoscopy

Communications

Imaging

Patient Handling Equipment

EMS Equipment

Stryker Trauma GmbH
Prof.-Küntscher-Strasse 1-5
D-24232 Schönkirchen
Germany

www.trauma.stryker.com

The information presented in this brochure is intended to demonstrate a Stryker product. Always refer to the package insert, product label and/or user instructions before using any Stryker product. Products may not be available in all markets. Product availability is subject to the regulatory or medical practices that govern individual markets. Please contact your Stryker representative if you have questions about the availability of Stryker products in your area.

Products referenced with ™ designation are trademarks of Stryker.
Products referenced with ® designation are registered trademarks of Stryker.

Literature Number: B0300008
LOT D1005

Copyright © 2005 Stryker
Printed in Germany

