

Table of Contents

Indications	2
Design Rationale	4
Design Features	5
Patient Prep	6
Surgical Technique	7
Catalog	20

Indications

Two-part fractures of the humerus
Three-part fractures of the humerus
Midshaft Diaphyseal Fracture(s)
Segmental Humerus Fracture(s)

Uncover an easier and more advanced nailing system

The TRIGEN Humeral Nail provides new possibilities for the treatment of proximal humeral fractures and humeral shaft fractures. With multiplanar screws that are threaded into the nail to inhibit proximal screw back-out, and effective, simple instrumentation that helps protect soft tissues, the TRIGEN System now offers an effective intramedullary nail for humeral fracture management.



Design Rationale

The TRIGEN Humeral Nailing System product offering includes a 16cm Proximal Straight Nail, a 16cm Proximal Bent Nail, and a full line of Long Bent Nails. Nails with a proximal bend are best suited for simple two-part fractures of the proximal humerus involving the surgical neck of the humerus and proximal third humeral fractures without comminution. In these scenarios, the Herzog curve facilitates an easier entry portal attainment and nail insertion with an incision just medial to the rotator cuff insertion.

The Long Bent Humeral Nail is primarily indicated for humeral shaft fractures which are inherently not prone to varus malposition. The lateral portal design allows insertion just medial to the rotator cuff insertion and facilitates easier portal attainment and nail insertion.

The 16cm Proximal Straight Humeral Nail offers the option of a medialized entry site. If the greater tuberosity is fractured or compromised, a straight centralized starting point avoids fracture extension from the tuberosity fracture into the entry portal and resultant loss of nail stability. The entry portal for the straight nail is slightly more difficult to attain than the curved nail entry portal.

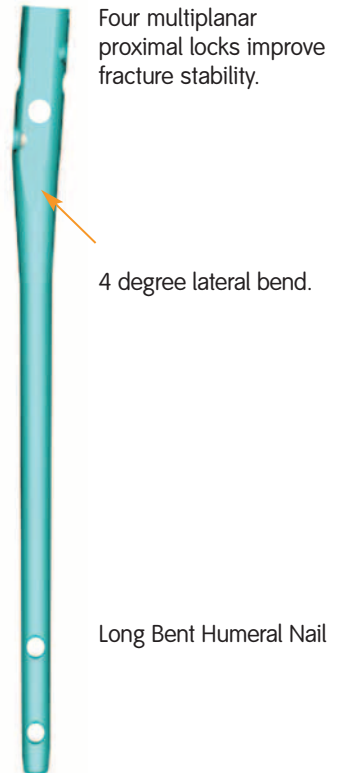

5.0mm Cancellous Proximal Locking Screws; 24mm – 64mm lengths, 2mm increments



4.0mm Cortical Distal Locking Screws; 20mm – 40mm lengths, 2mm increments

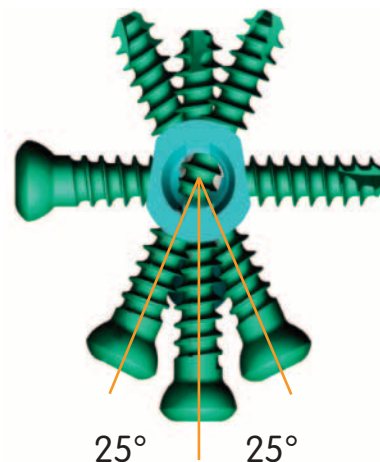

Proximal locking holes have innovative threaded design. Screws thread into the nail to help prevent screw back-out.

Design Features

Nail Specifications

TRIGEN
Humeral Nail 8/7mm X 16cm
Proximal Bent Humeral Nail

TRIGEN
Humeral Nail 8/7mm X 16cm
Proximal Straight Humeral Nail

TRIGEN
Long Bent Humeral Nail 8/7mm,
9/7.5mm, 10/8.5mm Diameter;
18cm – 28cm Lengths, by
2cm increments

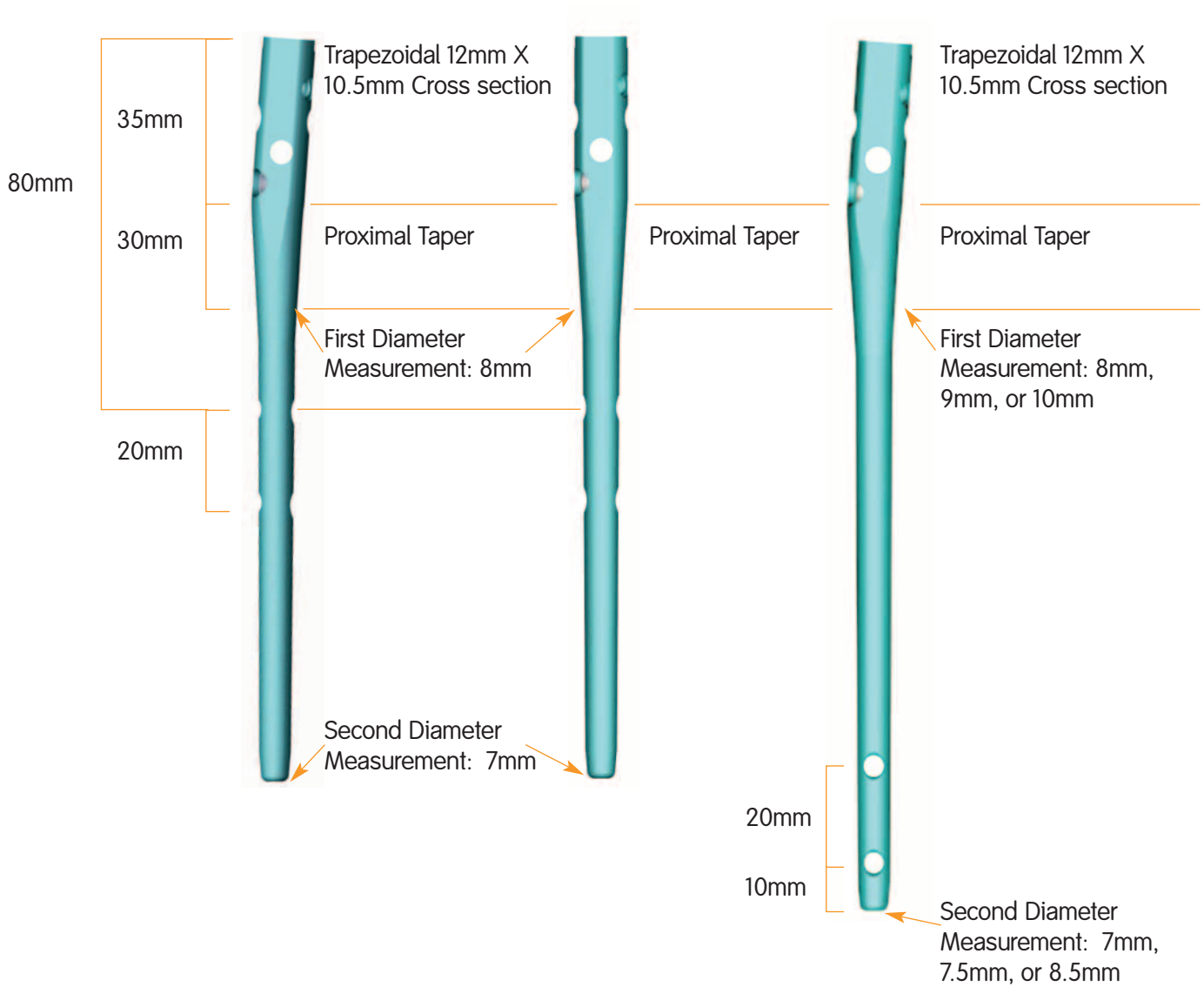

Patient Positioning

Supine Position

Position the patient supine with 3 liter bags of saline between scapulas. Lateralize the patient on the fluoroimage table so that the humerus may be extended posteriorly (*Figure 1*).

The C-arm may be positioned either superior to the shoulder or opposite the shoulder if the C-arm modus is large enough.

Alternative Position

Position the patient in a slight “beach-chair” position. The arm of the semi-recumbent patient is left to hang near the trunk thus its weight helps reposition the humeral head anterior to the acromion. The C-arm is placed above the head of the table at 30° extending distally over the shoulder. This will allow an anteroposterior view of the humerus. The arm should be placed in reverse pushing position to clear the entry point, anatomically located at the superior margin of the articular surface just medial to the greater tuberosity.

Once the correct positioning and imaging are assured, the shoulder and arm are prepped and draped.



Figure 1

Surgical Technique

Incision

The incision approach that is recommended and most often used for antegrade humeral nailing is the lateral deltoid splitting incision. For complete fractures or nonunions, a traditional deltopectoral approach may be used.

A 2-3cm incision is made from the edge of the acromion to the edge of the head of humerus, anterolateral to the tip of the acromion. The deltoid is divided down to the sub-deltoid bursa. The deltoid muscle is then retracted. Visualize the rotator cuff insertion into the greater tuberosity. The biceps tendon is palpated anteriorly. The rotator cuff supraspinatus tendon is incised 15-20mm in line with its fibers, exposing the humeral head. Insert suture into the rotator cuff interval to retract the rotator cuff and facilitate its repair after insertion of the nail (*Figure 2*).

Lateral Portal

Entry portal is made just medial to the tendon insertion and centered midway between the biceps groove anteriorly and the posterior humeral head (*Figure 3*).

Central Portal (Straight Proximal Nail)

Entry portal is made at the apex of the humeral head and centered midway between the biceps groove anteriorly and the posterior humeral head (*Figure 3*).

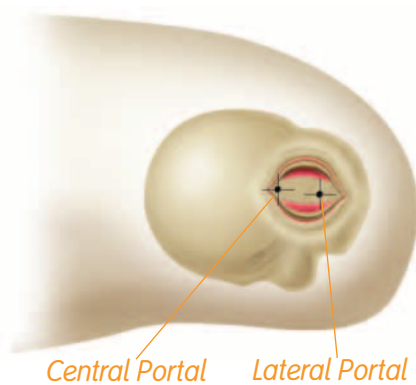

Figure 3

Surgical Technique

Entry Tool and Guide Pin Placement

The rotator cuff is divided to expose the superior portion of the humeral head. The Entry Cuff Guard protective device should be used to retract the soft tissue of the rotator cuff for visualization of the bone. The Cuff Guard provides a visual working channel, while protecting the rotator cuff and soft tissue during the procedure.



Figure 4

Attach the 3.2mm Tip Threaded Guide Pin or Trocar to the Mini Connector with Handle. Place through the Cuff Guard into the superior margin of the humeral head just medial to the greater tuberosity, avoiding the rotator cuff insertion (Figure 4).

Verify position on the C-arm to confirm guide pin placement is aligned in the medullary canal by oblique pictures at 45° with internal and external rotation of the shoulder.



7175-1100
Entry Cuff Guard



7175-1147
3.2mm Tip Threaded
Guide Pin



7175-1136
Trocar



7175-1137
Mini Connector
with Handle



Figure 5



Figure 6

Prepare Proximal Section

Insert the Straight Entry Reamer over the 3.2mm Tip Threaded Guide Pin or the Trocar through the Cuff Guard to prepare the humerus for the proximal section of the nail. Ream until the cutting teeth are just below the articular surface of the humeral head (Figure 5). The depth indicator on the reamer should be level with the top of the Cuff Guard.

The proximal humerus can also be prepared by using the Humeral Broach. The broaching method utilizes the noncylindrical shape of the proximal body of the nail to help rotationally stabilize the nail during insertion of the locking screws.

Use the Humeral Nail Guide Bolt to attach the Nail Drill Guide to the Broach (Figure 6). The Broach and the Nail Drill Guide are keyed to ensure proper orientation of the Broach on the Nail Drill Guide. Tighten down the Nail Guide Bolt using the Guide Bolt Wrench. The Impactor is then attached to the Nail Guide Bolt.

The awl-tip on the Humeral Broach can be used to perforate the cortical bone of the articular surface. The Broach should be inserted over the 3.2mm Tip Threaded Guide Pin or the Trocar. It may be necessary to use the Small Hammer to gently advance and retract the Broach to prepare the canal of the proximal humerus to accept the nail.

Alternatively, the Cannulated Awl can be used with the Straight Ratcheting Driver in place of the Broach.



7175-1103
Straight Entry Reamer

7175-1104
Humeral Broach

7175-1108
Humeral Nail
Guide Bolt

7175-1129
Nail Drill Guide

7175-1134
Guide Bolt Wrench

7175-1133
Impactor

7175-1135
Small Hammer

7175-1102
Cannulated Awl

Surgical Technique

Fracture Reduction

After removing the Straight Entry Reamer and 3.2mm Tip Threaded Guide Pin or Trocar, insert the Straight Reducer attached to the Straight Ratcheting Driver with the slot oriented toward the lateral cortex and reduce the fracture. Place the tip of the finger off the medial cortex to help reduce the fracture (Figure 7).

To maintain reduction, disconnect the Straight Ratcheting Driver from the Straight Reducer and introduce the 2.0mm Graduated Ball Tip Guide Rod through the Straight Reducer. Then reattach the Straight Ratcheting Driver to the Straight Reducer (Figure 8). Center the Guide Rod 1-2cm proximal to the olecranon fossa in the distal end of the humerus. Once the Guide Rod is in place, carefully remove the Straight Reducer, using the Obturator as needed to ensure the Guide Rod stays in place (Figure 9).

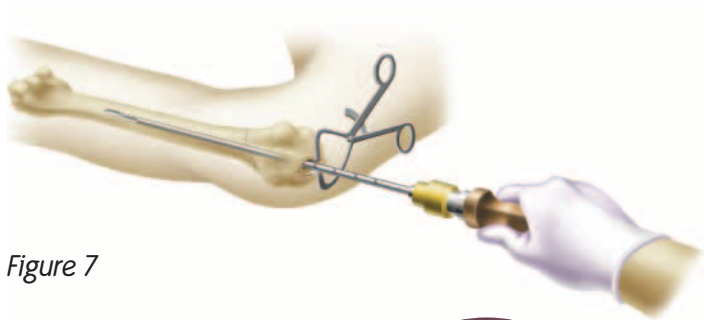

Figure 7

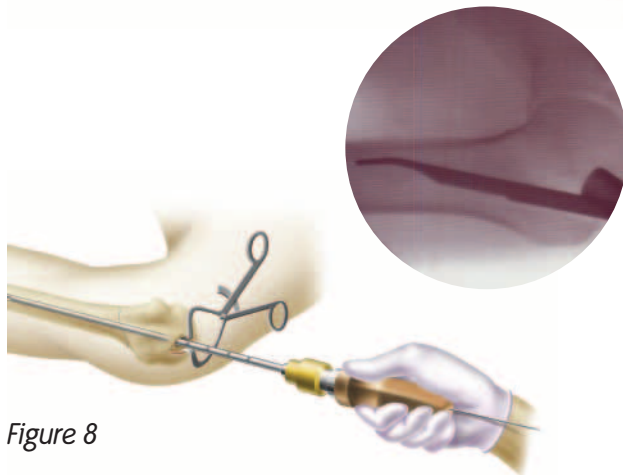

Figure 8

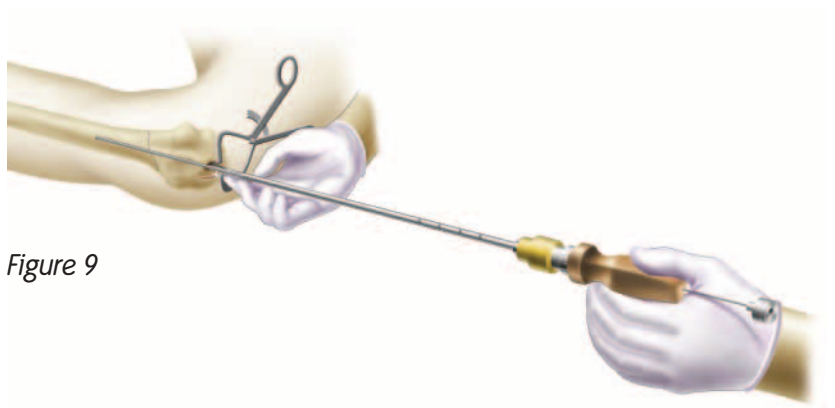

Figure 9



7175-1105
Straight Reducer



7175-1141
Straight Ratcheting
Driver



7175-1146
2.0mm Graduated
Ball Tip Guide Rod



7175-1145
Obturator

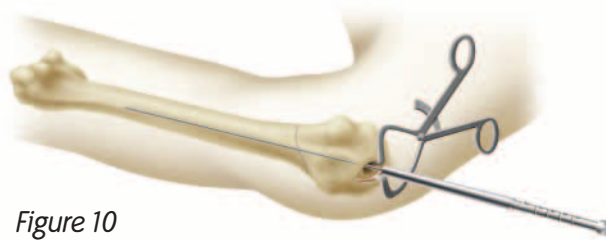

Figure 10

Measuring Implant Length

To measure the length of the implant needed, ensure that the distal tip of the 2.0mm Graduated Ball Tip Guide Rod is located at the desired position of the distal tip of the nail. Slide the Ruler over the proximal end of the 2.0mm Graduated Ball Tip Guide Rod and advance the open end of the Ruler to where the proximal portion of the implant will be seated, just below the articular surface of the proximal humerus. Read the nail length from the calibrations exposed at the other end of the Ruler (Figure 10).

The 2.0mm Graduated Ball Tip Guide Rod has graduated markings and can be used to determine required implant length. The Straight Reducer can also be used to determine implant length, by using the markings on the reducer shaft. Both options are used to directly measure to the articular surface, taking care to ensure the nail will be slightly countersunk.



Figure 11

Additional Limited Reaming

(Necessary for Proximal Nails Longer than 8mm X 16cm)

After the nail length has been determined, additional limited reaming can be performed to avoid nail incarceration and distraction at the fracture site during insertion of the nail. Choose a Flex Reamer and insert it over the 2.0mm Graduated Ball Tip Guide Rod. Be careful not to “push” the guide rod distally during reaming. Never insert a nail that has a larger diameter than the last reamer used (Figure 11).

It is recommended that templating is done for all cases to estimate the size of the implant needed. The diameter of the last reamer used will help determine the diameter of the implant needed. Keep in mind that all of the nail sizes taper, and the canal should be reamed to 1mm over the implant diameter.



7175-1126
Ruler



7175-1120
Flex Reamer

Surgical Technique

Nail Drill Guide Assembly

Once the implant selection is complete, use the Humeral Nail Guide Bolt to attach the Nail Drill Guide to the nail. The nail and Nail Drill Guide are keyed to ensure proper orientation of the nail on the Nail Drill Guide (*Figure 12*). **Note:** The metal threads on the proximal locking holes should always be lateral. Tighten the Humeral Nail Guide Bolt using the Guide Bolt Wrench. The Impactor is then attached to the Humeral Nail Guide Bolt.

To complete the assembly, attach the Proximal Drop to the lateral arm of the Nail Drill Guide (*Figure 13*). Tighten the Proximal Drop to the Guide using the knurled knob. The Proximal Drop should be used to target the proximal screws on all Humeral Nails, and the distal screws on the 16cm Proximal Nails. Distal locking screws for the 18cm or longer Humeral Nails should be targeted using a freehand technique.

Figure 12



Figure 13



The Humeral Nail and Nail Drill Guide are keyed to ensure proper orientation of the nail on the Nail Drill Guide.



7175-1131
Proximal Drop

Nail Insertion

At this point the nail is ready to be inserted. Care should be taken to insert the nail with the correct amount of retroversion and depth in order to maximize locking screw fixation while avoiding critical soft tissues such as the biceps tendon, axillary and radial nerves.

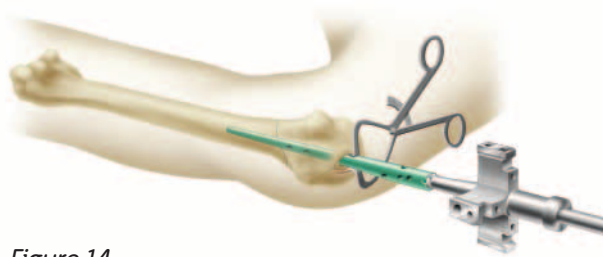

Figure 14

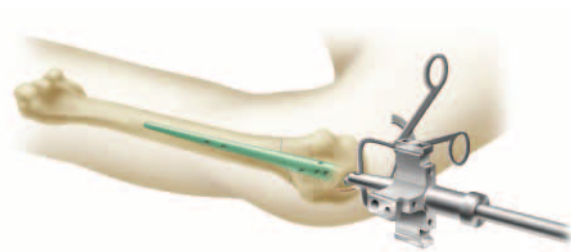

Figure 15



Figure 16

Insert the nail attached to the Nail Drill Guide Assembly over the 2.0mm Graduated Ball Tip Guide Rod and through the Cuff Guard with the lateral arm of the drill guide oriented with approximately 30-35° of retroversion (Figure 14). Adjustments to this version can be made so that the anterior arm of the drill guide is in line with the lesser tuberosity, avoiding alignment with the bicipital groove. Proper depth is achieved when the lateral ledge on the drill guide is above the lateral cortex and the nail is seated just below the articular surface (Figure 15).

Remove the Guide Rod from the top of the Nail Drill Guide. Confirm that the fracture is compacted and not distracted (Figure 16).

Surgical Technique

Final Version Adjustment

Final and rigid version adjustment to the nail can be performed prior to inserting the proximal locking screws by attaching the Anterior Stylus to the anterior arm of the Nail Drill Guide.

Insert the Trocar through the Anterior Stylus and position the nail so that the Trocar can be inserted into the lesser tuberosity at the location of the anterior locking hole. Leave the Trocar in place to maintain fracture reduction and rotational stability during the insertion of the proximal lateral screws (*Figure 17a*).

This step ensures that the proximal anterior and proximal anterolateral locking screws will not be inserted into the bicipital groove, potentially injuring the biceps tendon (*Figure 17b*).

Figure 17b



Figure 17a



7175-1130
Anterior Stylus

Proximal Locking Screws

Caution: Do not countersink the nail such that proximal locking screws are below the level of the humeral head to avoid damage to the axillary nerve.

In order to avoid impingement of the biceps tendon, it is a good idea to start with the proximal anterolateral locking screw. Place the 3.2mm Silver Inner Drill Sleeve into the Gold Outer Sleeve. Insert the sleeve unit into the Proximal Drop (*Figure 18*). The Trocar can be inserted into the sleeve unit to determine the exact location for the insertion of the locking screw. If the Trocar tip indicates the proximal anterolateral screw is in line with the bicipital groove, reorient the nail to avoid impingement. Once proper alignment has been achieved, make a stab incision and push the sleeve unit down to the bone. Use the Trocar to dimple the cortex. Remove the Trocar from the sleeve unit and drill through the near cortex, stopping at the articular surface of the far cortex using the 3.2mm Graduated Two-Flute Drill (*Figure 19*). Take the length measurement from the calibrations on the drill (*Figure 20*) or the Screw Depth Gauge (*Figure 21*). The 3.2mm Silver Inner Drill Sleeve must be removed from the Gold Outer Sleeve in order to use the Screw Depth Gauge.



Figure 18

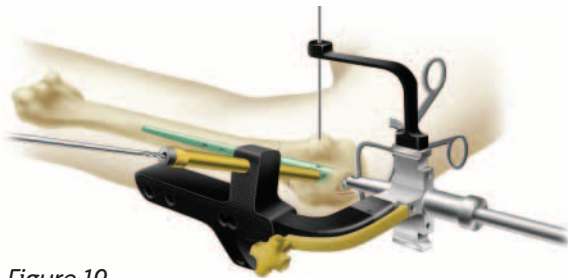

Figure 19

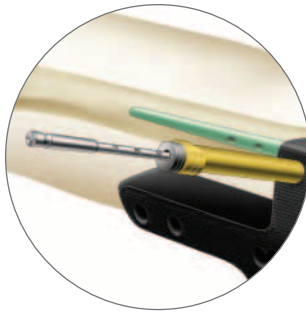

Figure 20



Figure 21



7175-1116
3.2mm Silver
Inner Drill Sleeve



7175-1128
Gold Outer Sleeve



7175-1149
3.2mm Graduated
Two-Flute Drill



7175-1139
Screw Depth Gauge

Surgical Technique

Proximal Locking Screws (Cont.)

Remove the 3.2mm Silver Inner Drill Sleeve and insert the 3.5mm Hex Driver with the appropriate length 5.0mm Cancellous Screw attached (*Figure 22*). The head of the screw should be nearly seated when the laser marked ring on the 3.5mm Hex Driver is even with the Gold Outer Sleeve. Final seating of the screw should always be under manual control using the Straight Ratcheting Driver to avoid over insertion of the screw in soft bone (*Figure 23*).

Insert the remaining two proximal locking screws.



Figure 22

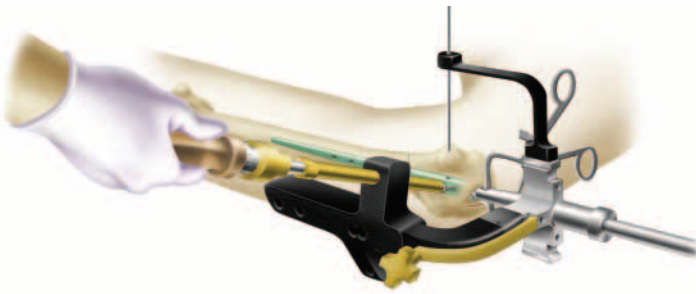

Figure 23



7175-1140
3.5mm Hex Driver

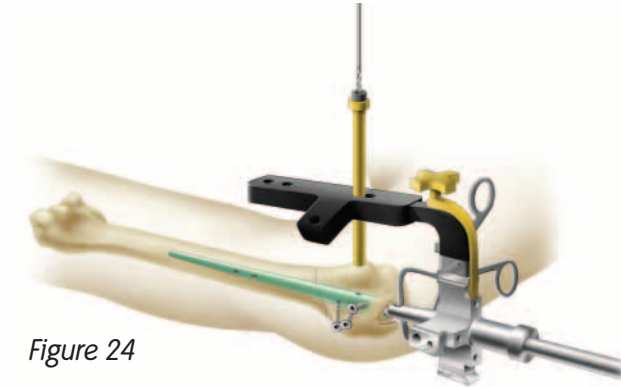

Figure 24

Proximal Locking Screws (Cont.)

To target the proximal anterior locking hole, remove the Anterior Stylus and attach the Proximal Drop on the anterior arm of the Nail Drill Guide. **Caution: Locate biceps tendon prior to beginning placement of the anterior screw.**

Insert the 3.2mm Silver Inner Drill Sleeve into the Gold Outer Sleeve. Insert the sleeve unit into the hole marked "Anterior" on the Proximal Drop (Figure 24).

Follow the same procedure described previously to drill, measure, and insert the Anterior and Posterior Proximal Screws, (Figures 24 - 28).

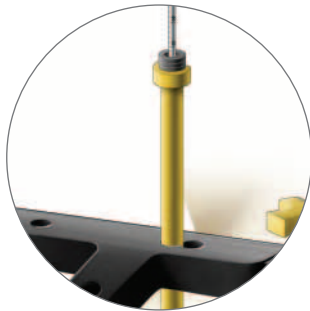

Figure 25

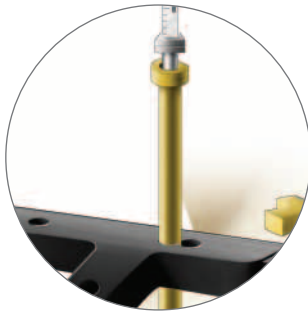

Figure 26

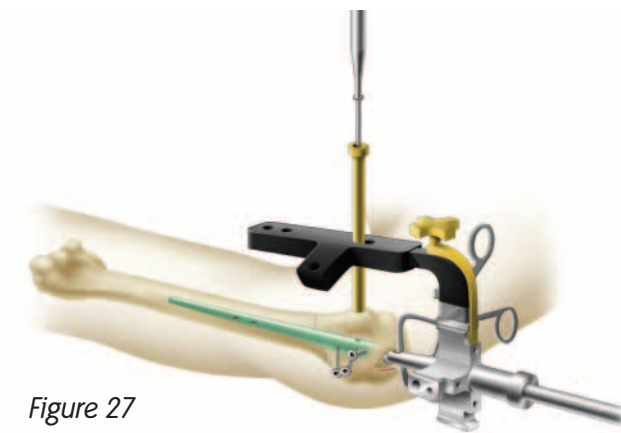

Figure 27

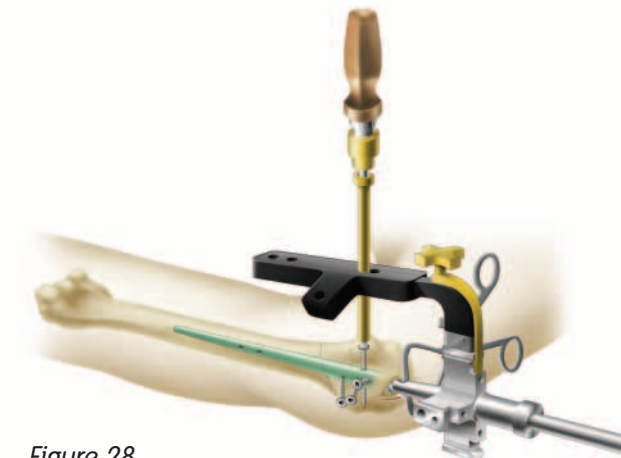

Figure 28

Surgical Technique

Distal Locking Screws

Note: The Proximal Drop only targets the distal holes for the 16cm nails. Nails longer than 16cm will be targeted using the freehand technique.

With the Proximal Drop connected to the lateral arm of the Nail Drill Guide, place the 3.2mm Silver Inner Drill Sleeve into the Gold Outer Sleeve. Insert the sleeve unit into the targeting hole in the Proximal Drop which corresponds to the superior M/L distal locking hole in the nail. While applying compression at the condyles of the elbow to reduce shaft fractures as needed, make a stab incision and push the sleeve unit down to the bone. The Trocar, in combination with the drill sleeve unit, may be used to dimple the cortex. Drill through both cortices using the 3.2mm Graduated Two-Flute Drill (*Figure 29*). A length measurement can be taken from the calibrations on the drill (*Figure 30*) against the 3.2mm Silver Inner Drill Sleeve, or the Screw Length Gauge can be used through the Gold Outer Sleeve to measure for distal locking screws (*Figure 31*).

Once the appropriate length 4.0mm Self-Tapping Cortical Screw is selected, it is attached to the 3.5mm Hex Driver. The screw is inserted through the Gold Outer Sleeve using the 3.5mm Hex Driver (*Figure 32*). The head of the screw should be nearly seated when the laser-marked ring on the Hex Driver is even with the Gold Outer Sleeve. Final tightening of the screw should always be performed manually using the Straight Ratcheting Driver (*Figure 33*). Repeat this process for the inferior distal screw.

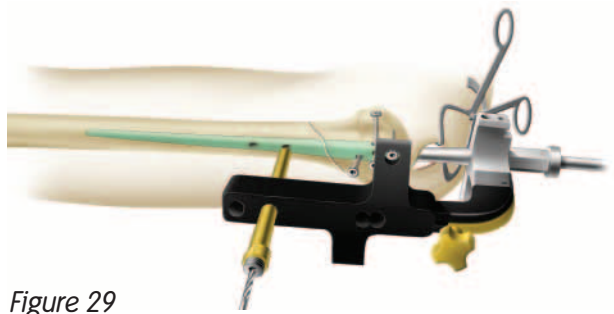

Figure 29



Figure 30



Figure 31

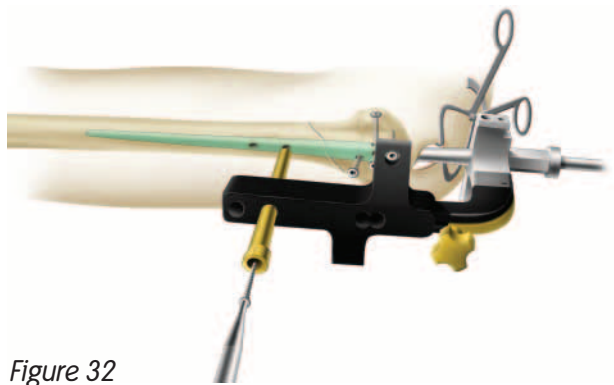

Figure 32



Figure 33

Distal Locking Screws (Cont.)

Freehand Locking

Distal locks on all nails 18cm and longer should be done using the freehand technique. The Screw Length Sleeve can be used with the 3.2mm Graduated Two-Flute Drill to drill for the A/P distal locks. Length measurements can be made by using the graduations on the drill against the Screw Length Sleeve. The Screw Length Gauge could also be used to determine the appropriate screw length. Once the appropriate length 4.0mm Self-Tapping Cortical Screw is selected, it is attached to the 3.5mm Hex Driver. The screw is inserted through the Gold Outer Sleeve using the 3.5mm Hex Driver. Final tightening of the screw should always be performed manually using the Straight Ratcheting Driver. Repeat this process for the inferior distal screw (*Figure 34*).



Figure 34

Closure

Close the wound in layers, use nonresorbable sutures in the rotator cuff repair. Close the remainder of the incision in a standard fashion.

Removal of the Nail

The Screw Head Trepine, the Proximal Nail Trepine and the Extractor are included in the instrument set to facilitate nail removal.



TRIGEN Humeral Nail Cap

(Not Shown)

Cat. No. 7176-0000



TRIGEN Proximal Straight Humeral Nail

Cat. No. **Size** **Length**

7176-0816 8/7mm 16cm



TRIGEN Proximal Bent Humeral Nail

Cat. No. **Size** **Length**

7177-0816 8/7mm 16cm



TRIGEN Long Bent Humeral Nail

Cat. No.	Size	Length	Cat. No.	Size	Length
7177-0818	8/7mm	18cm	7177-0924	9/7.5mm	24cm
7177-0820	8/7mm	20cm	7177-0926	9/7.5mm	26cm
7177-0822	8/7mm	22cm	7177-0928	9/7.5mm	28cm
7177-0824	8/7mm	24cm	7177-1018	10/8.5mm	18cm
7177-0826	8/7mm	26cm	7177-1020	10/8.5mm	20cm
7177-0828	8/7mm	28cm	7177-1022	10/8.5mm	22cm
7177-0918	9/7.5mm	18cm	7177-1024	10/8.5mm	24cm
7177-0920	9/7.5mm	20cm	7177-1026	10/8.5mm	26cm
7177-0922	9/7.5mm	22cm	7177-1028	10/8.5mm	28cm

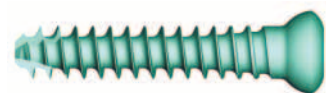

5.0mm Self-Tapping Cancellous Screw

Cat. No.	Length	Cat. No.	Length
7175-5024	24mm	7175-5046	46mm
7175-5026	26mm	7175-5048	48mm
7175-5028	28mm	7175-5050	50mm
7175-5030	30mm	7175-5052	52mm
7175-5032	32mm	7175-5054	54mm
7175-5034	34mm	7175-5056	56mm
7175-5036	36mm	7175-5058	58mm
7175-5038	38mm	7175-5060	60mm
7175-5040	40mm	7175-5062	62mm
7175-5042	42mm	7175-5064	64mm
7175-5044	44mm		



4.0mm Self-Tapping Cortical Screw

Cat. No.	Length	Cat. No.	Length
7175-4020	20mm	7175-4032	32mm
7175-4022	22mm	7175-4034	34mm
7175-4024	24mm	7175-4036	36mm
7175-4026	26mm	7175-4038	38mm
7175-4028	28mm	7175-4040	40mm
7175-4030	30mm		



Entry Cuff Guard

Cat. No. 7175-1100



Disposable Cuff Guard

(Not Shown)

Cat. No. 7175-1101



3.2mm Tip Threaded Guide Pin

Cat. No. 7175-1147

Trocar

Cat. No. 7175-1136

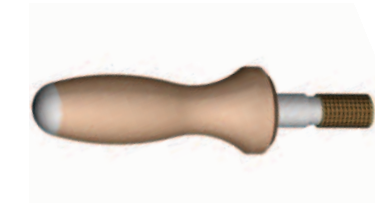

Mini Connector with Handle

Cat. No. 7175-1137



Straight Entry Reamer

Cat. No. 7175-1103



Humeral Broach

Cat. No. 7175-1104



Small Hammer

Cat. No. 7175-1135



Humeral Nail Guide Bolt

Cat. No. 7175-1108



Nail Drill Guide

Cat. No. 7175-1129



Guide Bolt Wrench

Cat. No. 7175-1134

Catalog



Impactor

Cat. No. 7175-1133



Straight Reducer

Cat. No. 7175-1105



Straight Ratcheting Driver

Cat. No. 7175-1141



2.0mm Graduated Ball Tip Guide Rod

Cat. No. 7175-1146



Obturator

Cat. No. 7175-1145



Ruler

Cat. No. 7175-1126



Flex Reamers

Size	Cat. No.
06.0mm	7175-1120
07.0mm	7175-1121
08.0mm	7175-1122
09.0mm	7175-1123
10.0mm	7175-1124
11.0mm	7175-1125



Proximal Drop

Cat. No. 7175-1131



Anterior Stylus

Cat. No. 7175-1130



3.2mm Silver Inner Drill Sleeve

Cat. No. 7175-1116

Catalog



Gold Outer Sleeve

Cat. No. 7175-1128

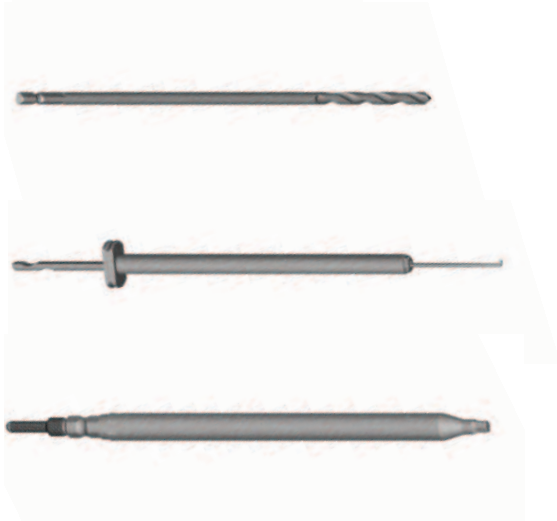

3.2mm Graduated Two-Flute Drill

Description Cat. No.

Short 7175-1148

Long 7175-1149



Screw Depth Gauge

Cat. No. 7175-1139



3.5mm Hex Driver

Cat. No. 7175-1140



AO Mini Connector

Cat. No. 7175-1153



Mini Connector

Cat. No. 7163-1186



Trinkle Connector

Cat. No. 7163-1187



Screw Head Trepine

Cat. No. 7175-1144



Proximal Nail Trepine

Cat. No. 7175-1143



Extractor

Cat. No. 7175-1142



Cannulated Awl

Cat. No. 7175-1102

Screw Length Sleeve

Cat. No. 11-0238

TRIGEN Humeral Nail Instrument Set

(Not Shown)

Cat. No. 7175-1150

Top Instrument Tray

(Not Shown)

Cat. No. 7175-1151

Bottom Instrument Tray

(Not Shown)

Cat. No. 7175-1152

Case

(Not Shown)

Cat. No. 7112-9400

Case Lid

(Not Shown)

Cat. No. 7112-9402

Reamer Cassette

Cat. No. 7175-1154

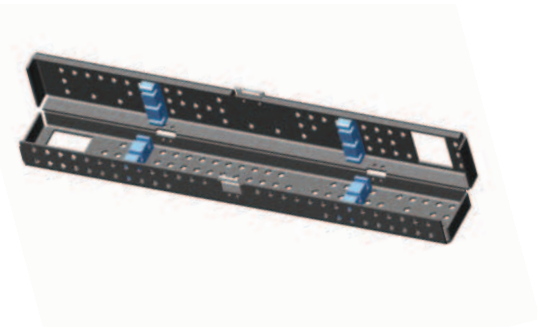

Notes

Notes

Orthopaedics

Smith & Nephew, Inc.
1450 Brooks Road
Memphis, TN 38116
USA

www.smith-nephew.com

Telephone: 901-396-2121
Information: 1-800-821-5700
Orders/Inquiries: 1-800-238-7538